

IRONLUX
GROUP 2003 S.A.

CATÁLOGO GENERAL

CERRAMIENTOS // LUCERNARIOS // ACCESORIOS

► ALMACÉN BARCELONA



2016

¿QUÉ GANA COMPRANDO EN IRONLUX



SERVICIO INTEGRAL

Trabajamos a diario para ofrecerles el **mejor servicio** e incorporar nuevos productos con el fin de adaptarnos a sus necesidades y aumentar su negocio.



APOYO TÉCNICO - COMERCIAL

Disponemos de un completo equipo de **profesionales a su disposición** para solventar cualquier duda que les pueda surgir y, si es necesario, acompañarles en las visitas a clientes.



PRESENCIA

Tenemos las puertas abiertas a nuestros clientes. Disponemos de **dos almacenes** con material en stock a los que podrán acudir para cualquier cuestión y responderemos a cualquier gestión post-venta.



DISPONIBILIDAD

Ante cualquier problema encontrarán una **respuesta rápida y ayuda eficaz** por parte de nuestro equipo profesional.



► CERRAMIENTOS

CUBIERTA ESTÁNDAR.....	4
CUBIERTA TEJA.....	6
FACHADA ESTÁNDAR	8
OTROS PANELES	11
PANEL A MEDIDA	12
LANA ROCA.....	13
PANEL FRIGORÍFICO.....	14
CÁMARAS FRIGORÍFICAS	15
CHAPA METÁLICA	16
CHAPA METÁLICA - TABIQUES PLUVIALES	17

► LUCERNARIOS

POLICARBONATO CELULAR ESTÁNDAR.....	18
POLICARBONATO CELULAR BAJO PEDIDO.....	20
INSTALACIÓN POLICARBONATO	21
SISTEMAS POLICARBONATO	22
POLICARBONATO CORRUGADO.....	25
POLIÉSTER.....	26
POLICARBONATO COMPACTO Y METACRILATO	27
LUCERNARIO TUBULAR - GLASS TOP.....	28
LUCERNARIO TUBULAR - FLAT TOP	29
CLARABOYAS MATACRILATO	30
SISTEMAS DE VENTILACIÓN.....	33
VENTANAS ROTO.....	34

► ACCESORIOS

REMATERÍA ESTÁNDAR	35
REMATERÍA PANEL TEJA	39
REMATERÍA A MEDIDA.....	41
ACCESORIOS DE POLICARBONATO	42
SISTEMA EVACUACIÓN AGUAS - PVC.....	43
SISTEMA EVACUACIÓN AGUAS - ACERO	45
ACCESORIOS FRIGORÍFICO	46
FIJACIONES.....	48
SISTEMAS DE PEGADO Y SELLADO.....	49
VARIOS	50
ESTRUCTURA LIGERA	51

CUBIERTA ESTÁNDAR





► GMPANEL CUBIERTA 5G (15) TORNILLO VISTO - (ROJO TEJA 7001 / BLANCO PIRINEO)

CÓDIGO: 0088

 5,95 Kg/m ²		FICHA TÉCNICA	ESPESOR (mm.)	PRECIO €/M ²
			15	21,00
		<p>● INTERIOR PERFILADO ESTÁNDAR</p>		
 119 kg 1500 mm. máx.	<p>● INTERIOR PERFILADO ESTÁNDAR</p>	<p>STOCK LONGITUDES → 3000 - 4500 - 6000 - 9000 mm.</p>	<p>ANCHO → 1000 mm.</p>	
<p>K(W/m²K)= 1,15</p>				





► GMPANEL TAPAJUNTAS (30) - (BLANCO PIRINEO / BLANCO PIRINEO)

CÓDIGO: 0001

 6,90 Kg/m ²		FICHA TÉCNICA	ESPESOR (mm.)	PRECIO €/M ²
			30	24,65
		<p>● INTERIOR PERFILADO ESTÁNDAR</p>		
 108 kg 2000 mm. máx.	<p>● INTERIOR PERFILADO ESTÁNDAR</p>	<p>STOCK LONGITUDES → 2000 - 2500 - 3000 - 3500 - 4000 - 4500 - 5000 - 6000 - 7000 mm.</p>	<p>ANCHO → 1000 mm.</p>	
<p>K(W/m²K)= 0,657</p>				

► GMPANEL TAPAJUNTAS (30) - (ROJO TEJA 7001 / BLANCO PIRINEO)

CÓDIGO: 0002

 6,90 Kg/m ²		FICHA TÉCNICA	ESPESOR (mm.)	PRECIO €/M ²
			30	25,35
		<p>● INTERIOR PERFILADO ESTÁNDAR</p>		
 108 kg 2000 mm. máx.	<p>● INTERIOR PERFILADO ESTÁNDAR</p>	<p>STOCK LONGITUDES → 2000 - 2500 - 3000 - 3500 - 4000 - 5000 - 6000 - 7000 mm.</p>	<p>ANCHO → 1000 mm.</p>	
<p>K(W/m²K)= 0,657</p>				

Clasificación fuego: **Cs3d0**

PRECIOS SIN IVA

CUBIERTA ESTÁNDAR

▶ GMPANEL TAPAJUNTAS (30) - (GRIS 7022 / BLANCO PIRINEO)

CÓDIGO: 0003

 7,80 Kg/m ²  108 kg 2000 mm. máx. K(W/m ² K)= 0,657	 ● INTERIOR PERFILADO ESTÁNDAR	FICHA TÉCNICA	ESPESOR (mm.)	PRECIO €/M ²
			30	27,50
		STOCK LONGITUDES ▶ 3000 - 4500 - 6000 - 9000 mm.		ANCHO ▶ 1000 mm.

▶ GMPANEL TAPAJUNTAS (50) - (BLANCO PIRINEO / BLANCO PIRINEO)

CÓDIGO: 0055

 7,70 Kg/m ²  95 kg 2750 mm. máx. K(W/m ² K)= 0,418	 ● INTERIOR PERFILADO EN LAMAS	FICHA TÉCNICA	ESPESOR (mm.)	PRECIO €/M ²
			50	29,25
		STOCK LONGITUDES ▶ 2000 - 2500 - 3000 - 3500 - 4000 - 4500 - 5000 - 6000 - 7000 - 9000 mm.		ANCHO ▶ 1000 mm.

▶ GMPANEL TAPAJUNTAS (80) - (BLANCO PIRINEO / BLANCO PIRINEO)

CÓDIGO: 0056

 8,70 Kg/m ²  99 kg 3500 mm. máx. K(W/m ² K)= 0,271	 ● INTERIOR PERFILADO EN LAMAS	FICHA TÉCNICA	ESPESOR (mm.)	PRECIO €/M ²
			80	35,90
		STOCK LONGITUDES ▶ 3000 - 4500 - 6000 - 9000 mm.		ANCHO ▶ 1000 mm.

CERRAMIENTOS

CUBIERTA TEJA



▶ GMPANEL TEJA ECO - (8004 / BLANCO PIRINEO)

CÓDIGO: 0067

 9,55 Kg/m ²	 <p>ESPESOR 45</p> <p>● INTERIOR PERFILADO ESTÁNDAR</p>	FICHA TÉCNICA	ESPESOR (mm.)	PRECIO €/M ²
 106 kg 2000 mm. máx.			45 PROMEDIO	40,45
K(W/m ² K)= 0,460		STOCK		

▶ GMPANEL TEJA - (8004 / BLANCO PIRINEO)

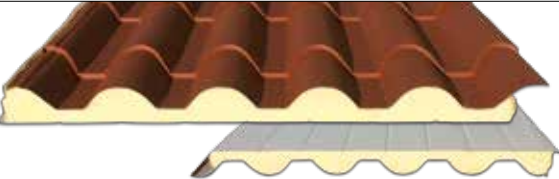
CÓDIGO: 0066

 9,95 Kg/m ²	 <p>● INTERIOR PERFILADO EN LAMAS</p>	FICHA TÉCNICA	ESPESOR (mm.)	PRECIO €/M ²
 106 kg 2800 mm. máx.			55 PROMEDIO	42,00
K(W/m ² K)= 0,390		STOCK		

▶ GMPANEL TEJA - (8004 / IMITACIÓN MADERA)

CÓDIGO: 0061

 10,80 Kg/m ²	 <p>● INTERIOR PERFILADO EN LAMAS</p>	FICHA TÉCNICA	ESPESOR (mm.)	PRECIO €/M ²
 106 kg 2800 mm. máx.			55 PROMEDIO	47,80
K(W/m ² K)= 0,390		STOCK		

Clasificación fuego: **Cs3d0**

PRECIOS SIN IVA

CUBIERTA TEJA



▶ GMPANEL TEJA - (GRIS PIZARRA / BLANCO PIRINEO)

CÓDIGO: 0066

 9,95 Kg/m ²		FICHA TÉCNICA	ESPESOR (mm.)	PRECIO €/M ²
			55 PROMEDIO	45,35
		 106 kg 2800 mm. máx.		
K(W/m ² K)=0,390	● INTERIOR PERFILADO EN LAMAS	STOCK LONGITUDES 1750 - 2450 - 3500 - 4900 mm.		ANCHO 1000 mm.

▶ GMPANEL TEJA - (ENVEJECIDO ALBERO / BLANCO PIRINEO)

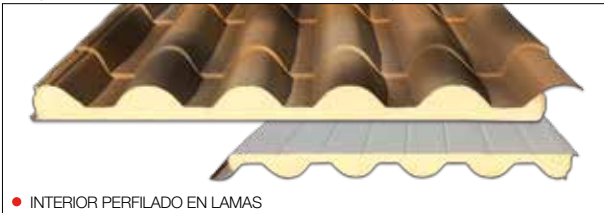
CÓDIGO: 0062

 9,95 Kg/m ²		FICHA TÉCNICA	ESPESOR (mm.)	PRECIO €/M ²
			55 PROMEDIO	49,85
		 106 kg 2800 mm. máx.		
K(W/m ² K)= 0,390	● INTERIOR PERFILADO EN LAMAS	STOCK LONGITUDES 1750 - 2450 - 3500 - 4900 mm.		ANCHO 1000 mm.

▶ GMPANEL TEJA - (ENVEJECIDO OSCURO / IMITACIÓN MADERA)

CÓDIGO: 0065





 10,80 Kg/m ²		FICHA TÉCNICA	ESPESOR (mm.)	PRECIO €/M ²
			55 PROMEDIO	53,10
		 106 kg 2800 mm. máx.		
K(W/m ² K)= 0,390	● INTERIOR PERFILADO EN LAMAS	STOCK LONGITUDES 1750 - 2450 - 3500 - 4900 mm.		ANCHO 1000 mm.

CERRAMIENTOS

FACHADA ESTÁNDAR

▶ GMPANEL TORNILLO VISTO (30) - (BLANCO PIRINEO / BLANCO PIRINEO)

CÓDIGO: 0004

 7,00 Kg/m ²		FICHA TÉCNICA	ESPESOR (mm.)	PRECIO €/M ²
 85 kg 2250 mm. máx.			30	23,65
K(W/m ² K)= 0,767		● PERFILADO POR AMBAS CARAS		
STOCK	LONGITUDES ▶ 2000 - 2500 - 3000 - 3500 - 4000 - 5000 - 6000 mm.	ANCHO ▶		1000 mm.

▶ GMPANEL TORNILLO VISTO (30) - (LISO / LISO)-(BLANCO PIRINEO / BLANCO PIRINEO)

CÓDIGO: 0006

 9,55 Kg/m ²		FICHA TÉCNICA	ESPESOR (mm.)	PRECIO €/M ²
 80 kg 2750 mm. máx.			30	29,15
K(W/m ² K)= 0,767		● LISO POR AMBAS CARAS		
STOCK	LONGITUDES ▶ 2500 - 3000 - 5000 - 6000 mm.	ANCHO ▶		1000 mm.

▶ GMPANEL TORNILLO VISTO (40) - (IMITACIÓN MADERA (EXTERIOR) / BLANCO PIRINEO)

CÓDIGO: 0057

 8,25 Kg/m ²		FICHA TÉCNICA	ESPESOR (mm.)	PRECIO €/M ²
 80 kg 3000 mm. máx.			40	32,65
K(W/m ² K)= 0,575		● INTERIOR PERFILADO ESTÁNDAR		
STOCK	LONGITUDES ▶ 3000 - 4500 - 6000 - 9000 mm.	ANCHO ▶		1000 mm.

Clasificación fuego: **Cs3d0**

PRECIOS SIN IVA

FACHADA ESTÁNDAR

▶ GMPANEL TORNILLO OCULTO (35) - (BLANCO PIRINEO / BLANCO PIRINEO) (Clasificación fuego: **Bs3d0**)

CÓDIGO: 0017





 8,05 Kg/m ²		FICHA TÉCNICA	ESPESOR (mm.)	PRECIO €/M ²
			35	26,85
 104 kg 2500 mm. máx.	● PERFILADO POR AMBAS CARAS	ANCHO → 1000 mm.		
K(W/m ² K) = 0,508	● STOCK ● LONGITUDES → 3000 - 4500 - 6000 - 9000 mm.			

**DISPONIBILIDAD DE OTROS ESPEORES,
COLORES Y ACABADOS**
CONSULTAR



▶ GMPANEL TORNILLO OCULTO (40) - (IMITACIÓN PIEDRA (EXTERIOR) / BLANCO PIRINEO) (Clasificación fuego: **Cs3d0**)

CÓDIGO: 0058

 9,10 Kg/m ²		FICHA TÉCNICA	ESPESOR (mm.)	PRECIO €/M ²
			40	47,45
 80 kg 3000 mm. máx.	● INSTALACIÓN HORIZONTAL	ANCHO → 1000 mm.		
K(W/m ² K) = 0,575	● STOCK ● LONGITUDES → 3000 - 4500 - 6000 - 9000 mm.			

CERRAMIENTOS

FACHADA ESTÁNDAR

► GMPANEL TORNILLO VISTO (50) - (LISO / LISO) - (BLANCO PIRINEO / BLANCO PIRINEO)

CÓDIGO: 0019

 10,35 Kg/m ²	 <p>● LISO POR AMBAS CARAS</p>	FICHA TÉCNICA	ESPESOR (mm.)	PRECIO €/M ²
 3250 mm. máx.			50	34,90
K(W/m ² K)=0,460		STOCK LONGITUDES → 3000 - 4000 - 5000 - 6000 mm.	ANCHO → 1000 mm.	

► GMPANEL TORNILLO VISTO (60) - (BLANCO PIRINEO / BLANCO PIRINEO)

CÓDIGO: 0005

 8,20 Kg/m ²	 <p>● PERFILADO POR AMBAS CARAS</p>	FICHA TÉCNICA	ESPESOR (mm.)	PRECIO €/M ²
 3000 mm. máx.			60	29,80
K(W/m ² K)= 0,383		STOCK LONGITUDES → 2500 - 3000 - 5000 - 6000 mm.	ANCHO → 1000 mm.	

SERVICIOS

- DESPIECE Y CORTE GRATUITOS
- CORTE Y VACIADO PARA SOLAPE : **8,00 €/ud.***
- PINTADO DE PANELES : **12,00 €/m²** (Por cara)*

* PRECIOS NETOS

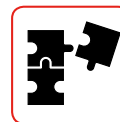

Clasificación fuego: **Cs3d0**

PRECIOS SIN IVA

OTROS PANELES (Consultar disponibilidad)

▶ GMPANEL TAPAJUNTAS (30) - (BLANCO PIRINEO /IMITACIÓN MADERA)

 7,80 Kg/m ²  108 kg 2000 mm. máx. K(W/m ² K)= 0,657	 <p>● INTERIOR PERFILADO EN LAMAS</p>	F. TÉCNICA	ESPESOR (mm.)	CÓDIGO: 0007 PRECIO €/M ²
			30	33,55
		BAJO PEDIDO LONGITUDES ▶ CONSULTAR		ANCHO ▶

▶ GMPANEL TAPAJUNTAS (50) - (NEGRO DEXTAR / BLANCO PIRINEO)

 7,70 Kg/m ²  95 kg 2750 mm. máx. K(W/m ² K)= 0,418	 <p>● INTERIOR PERFILADO ESTÁNDAR</p>	F. TÉCNICA	ESPESOR (mm.)	CÓDIGO: 0116 PRECIO €/M ²
			50	30,80
		BAJO PEDIDO LONGITUDES ▶ 3000 - 4500 - 6000 - 9000 mm.		ANCHO ▶

▶ GMPANEL TEJA - (ENVEJECIDO ALBERO / IMITACIÓN MADERA)

 10,80 Kg/m ²  106 kg 2800 mm. máx. K(W/m ² K)=0,390	 <p>● INTERIOR PERFILADO EN LAMAS</p>	F. TÉCNICA	ESPESOR (mm.)	CÓDIGO: 0063 PRECIO €/M ²
			55 PROMEDIO	54,65
		BAJO PEDIDO LONGITUDES ▶ CONSULTAR		ANCHO ▶

▶ GMPANEL PIZARRA (IMITACIÓN PIZARRA - BLANCO PIRINEO)

 9,90 Kg/m ²  100 kg 3500 mm. máx. K(W/m ² K)= 0,344	 <p>● INSTALACIÓN HORIZONTAL</p>	F. TÉCNICA	ESPESOR (mm.)	CÓDIGO: 0118 PRECIO €/M ²
			60	67,95
		BAJO PEDIDO LONGITUDES ▶ CONSULTAR		ANCHO ▶

PANEL A MEDIDA

► GMPANEL CUBIERTA - TORNILLERÍA OCULTA

CÓDIGO: 0009



● ANCHO ÚTIL 1.150 MM



FICHA TÉCNICA

ESPESOR (mm.)

PRECIO €/M²

30
40
50
60
80

30,90
33,65
36,50
39,35
44,95

ESTÁNDAR:

Blanco Pirineo
Rojo Teja

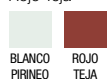

ESPECIALES:

El resto. (- de 100m², recargo de 300 €)
Opciones de tono madera, consultar.



BAJO PEDIDO

LONGITUD

A MEDIDA

ANCHO

1150 mm.

► GMPANEL FACHADA - TORNILLERÍA OCULTA

CÓDIGO: 0010



● ANCHO ÚTIL 1.150 MM

● PERFILADO AMBAS CARAS
(Posibilidad de otros perfilados)



FICHA TÉCNICA

ESPESOR (mm.)

PRECIO €/M²

35
40
50
60
80

33,20
34,50
37,25
40,00
45,60

ESTÁNDAR:

Blanco Pirineo
Silver Metálic



ESPECIALES:

El resto. (- de 100m², recargo de 300 €)
Opciones de tono madera, consultar.



BAJO PEDIDO

LONGITUD

A MEDIDA

ANCHO

1150 mm.

▶ GMPANEL CUBIERTA LANA DE ROCA (50) - (BLANCO PIRINEO / BLANCO PIRINEO)

CÓDIGO: 0068

 14,74 Kg/m ²		F. TÉCNICA 	ESPESOR (mm.)	PRECIO €/M ²
			50	47,10
 106kg 2750 mm. máx.	● INTERIOR PERFILADO ESTÁNDAR REI 30	ANCHO	1000 mm.	
K(W/m ² K) = 0,618 STOCK LONGITUDES 3000 - 6000 mm.				

▶ GMPANEL LANA DE ROCA ACÚSTICO (50) - (BLANCO PIRINEO / BLANCO PIRINEO)

CÓDIGO: 0071

 13,10 Kg/m ²		F. TÉCNICA 	ESPESOR (mm.)	PRECIO €/M ²
			50	49,95
 90 kg 2000 mm. máx.	● CHAPA PERFORADA UNA CARA 29 db	ANCHO	1000 mm.	
K(W/m ² K) = 0,680 STOCK LONGITUDES 3000 - 6000 mm.				

▶ GMPANEL FACHADA LANA DE ROCA (80) - (BLANCO PIRINEO / BLANCO PIRINEO)

CÓDIGO: 0069

 16,40 Kg/m ²		F. TÉCNICA 	ESPESOR (mm.)	PRECIO €/M ²
			80	51,95
 95 kg 3750 mm. máx.	● PERFILADO AMBAS CARAS EI 60	ANCHO	1000 mm.	
K(W/m ² K) = 0,425 STOCK LONGITUDES 3000 - 6000 mm.				

▶ GMPANEL FACHADA LANA DE ROCA (100) - (BLANCO PIRINEO / BLANCO PIRINEO)

CÓDIGO: 0070

 18,40 Kg/m ²		F. TÉCNICA 	ESPESOR (mm.)	PRECIO €/M ²
			100	57,05
 90 kg 4750 mm. máx.	● PERFILADO AMBAS CARAS EI 120	ANCHO	1000 mm.	
K(W/m ² K) = 0,340 STOCK LONGITUDES 3000 - 6000 mm.				

PANEL FRIGORÍFICO

▶ **GMPANEL TORNILLO VISTO (60) - (BLANCO PIRINEO / BLANCO PIRINEO)** (Clasificación fuego: **Cs3d0**)

CÓDIGO: 0005

 8,20 Kg/m ²	 <p>● PERFILADO POR AMBAS CARAS</p>	FICHA TÉCNICA	ESPESOR (mm.)	PRECIO €/M ²
 80 kg 3000 mm. máx.			60	29,80
$K(W/m^2K) = 0,383$		STOCK LONGITUDES → 2500 - 3000 - 5000 - 6000 mm.	ANCHO → 1000 mm.	

▶ **GMPANEL FRIGORÍFICO (80) - (BLANCO PIRINEO / BLANCO PIRINEO)** (Clasificación fuego: **Bs3d0**)

CÓDIGO: 0072

 10,75 Kg/m ²	 <p>● PERFILADO POR AMBAS CARAS</p>	FICHA TÉCNICA	ESPESOR (mm.)	PRECIO €/M ²
 107 kg 5000 mm. máx.			80	34,85
$K(W/m^2K) = 0,288$		STOCK LONGITUDES → 3000 - 4500 - 6000 - 9000 mm.	ANCHO → 1000 mm.	

▶ **GMPANEL FRIGORÍFICO (100) - (BLANCO PIRINEO / BLANCO PIRINEO)** (Clasificación fuego: **Bs3d0**)

CÓDIGO: 0073

 11,55 Kg/m ²	 <p>● PERFILADO POR AMBAS CARAS</p>	FICHA TÉCNICA	ESPESOR (mm.)	PRECIO €/M ²
 95 kg 6000 mm. máx.			100	39,25
$K(W/m^2K) = 0,230$		BAJO PEDIDO LONGITUDES → CONSULTAR	ANCHO → 1125 mm.	

CÁMARAS FRIGORÍFICAS



DISPONIBILIDAD DE PERFILERÍA SANITARIA (ver pág. 46-47),
PUERTAS, SUELOS Y EQUIPOS DE FRÍO
(Consultar modelos y condiciones)



CHAPA METÁLICA

▶ CHAPA METÁLICA GRECADA CUBIERTA

CÓDIGO: 0012



FICHA TÉCNICA	ESPESOR (mm.)	COLOR	PRECIO €/M ²
	0,6	GALVANIZADO (30/206)	9,90 12,10
		PRELACADO BP /RT (30/210)	

STOCK GALVANIZADO **LONG.** ▶ 3000 - 6000 mm. **ANCHO** ▶ 1030 mm. PRELACADO **LONG.** ▶ 3000 - 6000 mm. **ANCHO** ▶ 1050 mm.

▶ CHAPA PERFILADA TEJA

CÓDIGO: 0015



FICHA TÉCNICA	ESPESOR (mm.)	COLOR	PRECIO €/M ²
	0,6	RAL 8004	17,05

STOCK RAL 8004 **LONG.** ▶ 4470 mm. **ANCHO** ▶ 1000 mm.

▶ FORJADO COLABORANTE

CÓDIGO: 0014

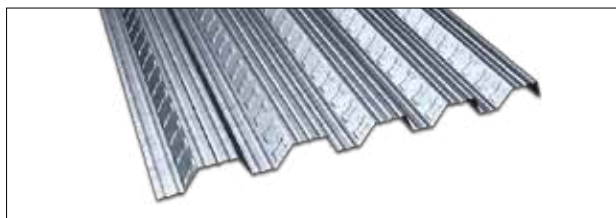

FICHA TÉCNICA	ESPESOR (mm.)	COLOR	PRECIO €/M ²
	0,8	GALVANIZADO	19,00

BAJO PEDIDO CONSULTAR

BP: Blanco pirineo // RT: Rojo teja 7001

PRECIOS SIN IVA

CHAPA METÁLICA - TABIQUES PLUVIALES

▶ CHAPA METÁLICA MINIONDA

CÓDIGO: 0011



FICHA TÉCNICA



ESPESOR (mm.)

0,6

COLOR

GALVANIZADO

PRELACADO

PRECIO €/M²

12,20
14,10

BAJO PEDIDO

LONGITUDES

A MEDIDA

ANCHO

1064 mm.

▶ CHAPA TABIQUE PLUVIAL (14/195/590)

CÓDIGO: 0013

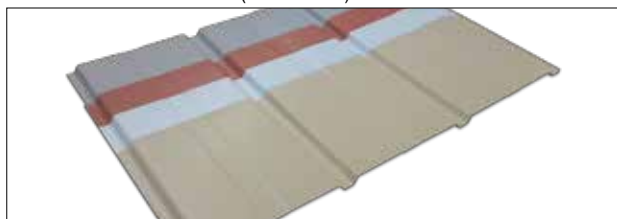

FICHA TÉCNICA



ESPESOR (mm.)

0,6

COLOR

BLANCO PIRINEO

ARENA

SALMÓN

GRIS PERLA

PRECIO €/M²

16,35

BAJO PEDIDO

LONGITUDES

2500 mm.

ANCHO

590 mm.

▶ CHAPA METÁLICA GRECADA FACHADA

CÓDIGO: 0012B



FICHA TÉCNICA



ESPESOR (mm.)

0,6

COLOR

GALVANIZADO

PRELACADO

PRECIO €/M²

9,90
12,10

BAJO PEDIDO

LONGITUDES

A MEDIDA

ANCHO

CONSULTAR

CERRAMIENTOS

POLICARBONATO CELULAR ESTÁNDAR

▶ POLICARBONATO CELULAR 6MM

CÓDIGO: 0078

3,50 W/M2K			ESPESOR (mm.)	COLOR	PRECIO €/M ²
18 dB			6	INCOLORO (TRANSPARENTE)	11,65
Transmisión de luz: INCOLORO: 82% OPAL: 58%	● INCOLORO	● OPAL		OPAL (TRASLÚCIDO)	12,30
PROTECCIÓN UV 2 CARAS			OPAL		
80KG Dist. máx. 510 mm.	STOCK	INCOLORO	LONG. → 3000 - 6000 mm.	ANCHO → 2100 mm.	
			OPAL	LONG. → 3000 - 6000 mm.	ANCHO → 2100 mm.

▶ POLICARBONATO CELULAR 6MM - REPETICIÓN LUCERNARIO

CÓDIGO: 0022

3,50 W/M2K			ESPESOR (mm.)	COLOR	PRECIO €/M ²
18 dB			6	INCOLORO (TRANSPARENTE)	13,40
Transmisión de luz: INCOLORO: 82% OPAL: 58%	● INCOLORO	● OPAL		OPAL (TRASLÚCIDO)	14,20
PROTECCIÓN UV 2 CARAS			OPAL		
80KG Dist. máx. 510 mm.	STOCK	INCOLORO	LONG. → 1195 mm.	ANCHO → 595 mm.	
			OPAL	LONG. → 1195 mm.	ANCHO → 595 mm.

▶ POLICARBONATO CELULAR 8MM

CÓDIGO: 0079

3,30 W/M2K			ESPESOR (mm.)	COLOR	PRECIO €/M ²
18 dB			8	INCOLORO (TRANSPARENTE)	13,40
Transmisión de luz: INCOLORO: 82% OPAL: 54%	● INCOLORO	● OPAL		OPAL (TRASLÚCIDO)	14,20
PROTECCIÓN UV 2 CARAS			OPAL		
80KG Dist. máx. 600 mm.	STOCK	INCOLORO	LONG. → 3000 - 6000 mm.	ANCHO → 2100 mm.	
			OPAL	LONG. → 3000 - 6000 mm.	ANCHO → 2100 mm.

Clasificación fuego: **Bs1d0**

PRECIOS SIN IVA

POLICARBONATO CELULAR ESTÁNDAR



▶ POLICARBONATO CELULAR 10MM

CÓDIGO: 0080

2,70 W/M2K			ESPESOR (mm.)	COLOR	PRECIO €/M ²
19 dB			10	INCOLORO (TRANSPARENTE)	15,20
Transmisión de luz: INCOLORO: 81% OPAL: 48%				OPAL (TRASLÚCIDO)	16,10
PROTECCIÓN UV 2 CARAS	● INCOLORO ● OPAL		OPAL	LONG. 2000 - 3000 - 4000 6000 - 7000 mm.	ANCHO 2100 mm.
80KG Dist. máx. 700 mm.	STOCK	INCOLORO	LONG. 2000 - 3000 - 4000 5000 (Ancho 2100 mm) 6000 - 7000 mm.	ANCHO 1200 2100 mm.	

▶ POLICARBONATO CELULAR 16MM

CÓDIGO: 0081

2,40 W/M2K			ESPESOR (mm.)	COLOR	PRECIO €/M ²
21 dB			16	INCOLORO (TRANSPARENTE)	24,15
Transmisión de luz: INCOLORO: 76% OPAL: 48%				OPAL (TRASLÚCIDO)	25,55
PROTECCIÓN UV 2 CARAS	● INCOLORO ● OPAL		OPAL	LONG. 2000 - 3000 - 4000 6000 - 7000 mm.	ANCHO 2100 mm.
80KG Dist. máx. 1000 mm.	STOCK	INCOLORO	LONG. 2000 - 3000 - 4000 6000 - 7000 mm.	ANCHO 1200 2100 mm.	

FICHAS TÉCNICAS POLICARBONATO CELULAR

			
6 mm.	8 mm.	10 mm.	16 mm.





SERVICIO DE CORTE
(LONGITUDINAL Y TRANSVERSAL)
GRATUITO

SOPLADO Y ENCINTADO
2,00 € / ML (Precio neto)

POLICARBONATO CELULAR (Bajo pedido)



▶ POLICARBONATO CELULAR 25MM

CÓDIGO: 0082

1,40 W/M2K			ESPESOR (mm.)	COLOR	PRECIO €/M ²
23 dB			25	INCOLORO (TRANSPARENTE)	32,65
Transmisión de luz: INCOLORO: 51% OPAL: 44%	● INCOLORO	● OPAL		OPAL (TRASLÚCIDO)	34,60
PROTECCIÓN UV 2 CARAS	BAJO PEDIDO INCOLORO LONG. 6000 mm. ANCHO 2100 mm.		OPAL LONG. 6000 y 7000 mm. ANCHO 2100 mm.		
80KG Dist. máx. 1250 mm.					

▶ POLICARBONATO CELULAR 32MM

CÓDIGO: 0083

1,40 W/M2K			ESPESOR (mm.)	COLOR	PRECIO €/M ²
23 dB			32	INCOLORO (TRANSPARENTE)	35,45
Transmisión de luz: INCOLORO: 38% OPAL: 20%	● INCOLORO	● OPAL		OPAL (TRASLÚCIDO)	37,55
PROTECCIÓN UV 2 CARAS	BAJO PEDIDO INCOLORO LONG. 2500 - 3000 - 3500 4000 - 4500 - 5000 7000 mm. ANCHO 1200 mm.		OPAL LONG. 2500 - 3000 - 3500 4000 - 4500 - 5000 7000 mm. ANCHO 1200 mm.		
80KG Dist. máx. 1250 mm.					

FICHAS TÉCNICAS POLICARBONATO CELULAR



25 mm.



32 mm.



SERVICIO DE CORTE
(LONGITUDINAL Y TRANSVERSAL)
GRATUITO

SOPLADO Y ENCINTADO
2,00 € / ML (Precio neto)

INSTALACIÓN POLICARBONATO

► PERFIL UNIVERSAL

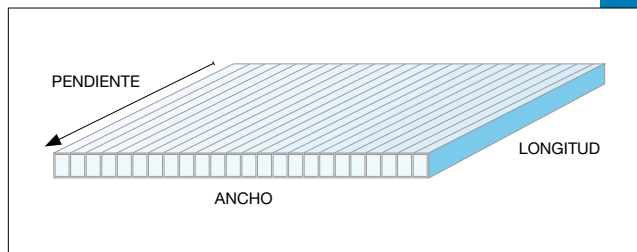
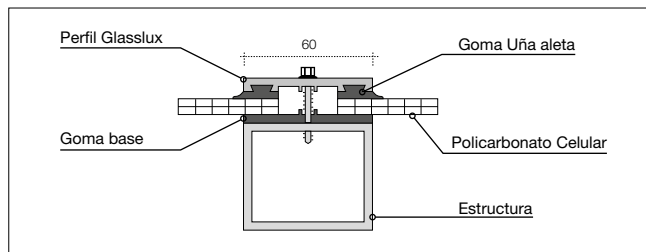

► INSTALACIÓN CON PERFILERÍA DE ALUMINIO

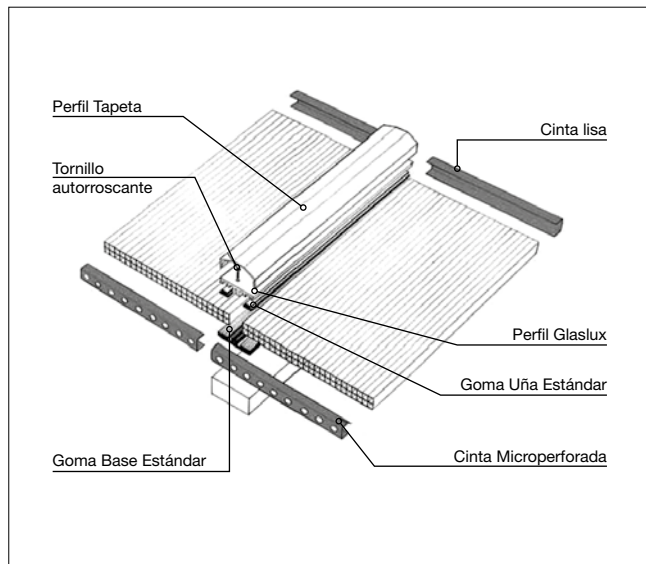

► INSTALACIÓN CON PERFILERÍA PLÁSTICA

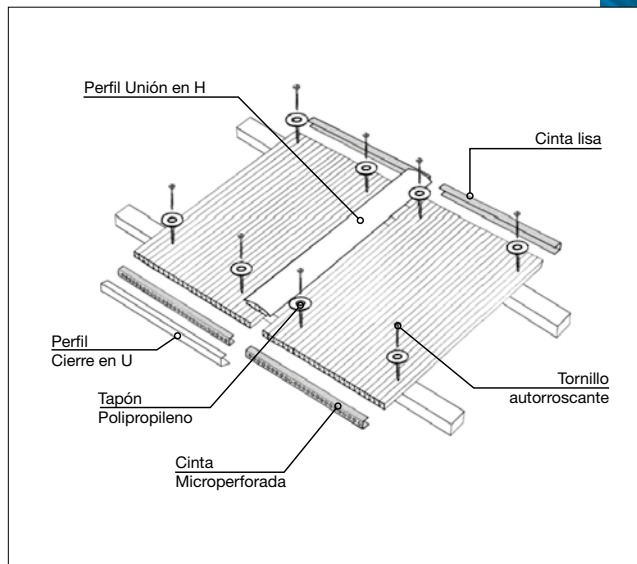

SISTEMAS POLICARBONATO

▶ GM SISPOL 30MM PARA PANEL (Clasificación fuego **Bs2d0**)

CÓDIGO: 0023

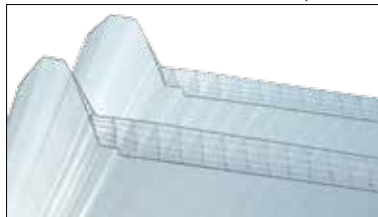

DISPONIBILIDAD DE LOS ACCESORIOS
PARA SU CORRECTA INSTALACIÓN
(Ver sección remates. pág.38 y 40)

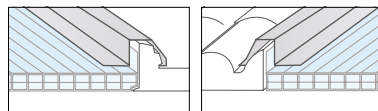

ESPESOR (mm.)	COLOR	PRECIO €/M ²
30	OPAL (TRASLÚCIDO)	46,20
3000 - 4000 - 6000 - 8000 - 12000 mm.		ANCHO 1000 mm.

STOCK INCOLORO **BAJO PEDIDO**

OPAL **LONG.**

▶ GM SISPOL GRECA 5 (Clasificación fuego **Bs1d0**)

CÓDIGO: 0027

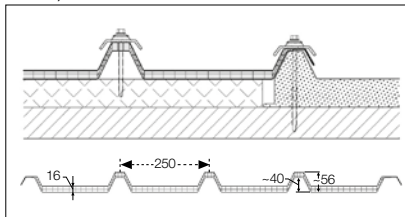

ESPESOR (mm.)	COLOR	PRECIO €/M ²
10	INCOLORO	33,80
	OPAL	35,85
16	INCOLORO	41,10
	OPAL	43,55

BAJO PEDIDO CONSULTAR

▶ GM SISPOL ONDA GM01 - 177/51 - 6,0 MM. - 2 PAREDES (Clasificación fuego **Bs1d0**)

CÓDIGO: 0026

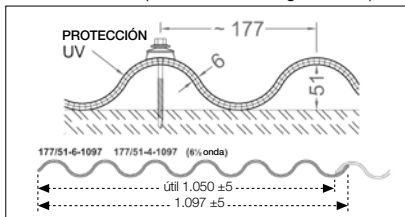

ESPESOR (mm.)	COLOR	PRECIO €/M ²
6	INCOLORO (TRANSPARENTE)	28,35
	OPAL (TRASLÚCIDO)	29,70

BAJO PEDIDO CONSULTAR

SISTEMAS POLICARBONATO

► GM SISPOL SISTEMA C4

CÓDIGO: 0024

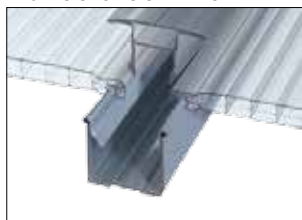

DISPONIBILIDAD DE LOS ACCESORIOS
PARA SU CORRECTA INSTALACIÓN
(Consultar)

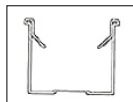

ESPESOR (mm.)	COLOR	PRECIO €/M²
10	INCOLORO	37,90 40,60 45,00 48,30
	OPAL	
16	INCOLORO	
	OPAL	

BAJO PEDIDO	INCOLORO	LONG. ►	CONSULTAR	ANCHO ►	500 mm.	OPAL	LONG. ►	CONSULTAR	ANCHO ►	500 mm.
--------------------	----------	----------------	-----------	----------------	---------	------	----------------	-----------	----------------	---------



LUCERNARIOS

SISTEMAS POLICARBONATO

► GM SISPOL SISTEMA MODULAR 40MM (Clasificación fuego: **Bs2d0**)

CÓDIGO: 0025

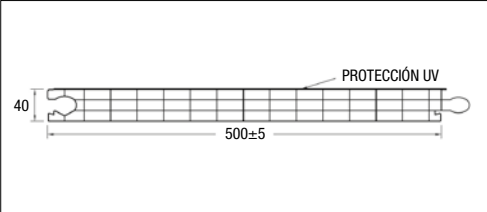
		ESPESOR (mm.)	COLOR	PRECIO €/M ²			
		40	INCOLORO (TRANSPARENTE) OPAL (TRASLÚCIDO)	56,35 59,30			
STOCK	INCOLORO	BAJO PEDIDO	OPAL	LONG.	3000 - 6000 mm.	ANCHO	500 mm.

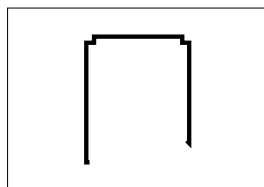

ALUMINIO ANODIZADO

Perfil SUPERIOR	€/ml.
STOCK	6.000 mm. 10,00

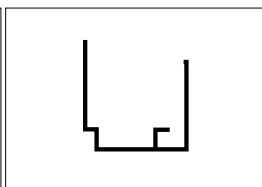

ALUMINIO ANODIZADO

Perfil INFERIOR	€/ml.
STOCK	6.000 mm. 11,00

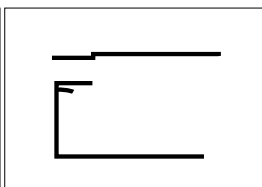

ALUMINIO ANODIZADO

Perfil LATERAL	€/ml.
STOCK	6.000 mm. 13,00

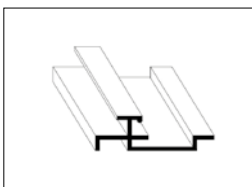

ALUMINIO ANODIZADO

Llave de FIJACIÓN	€/ud.
STOCK	ud. 2,95

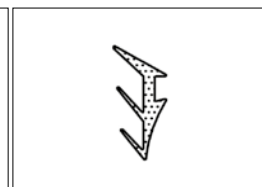

M767

Goma PERIMETRAL	€/ml.
STOCK	ml. 1,50

SISTEMA DE FIJACIÓN A ESTRUCTURA

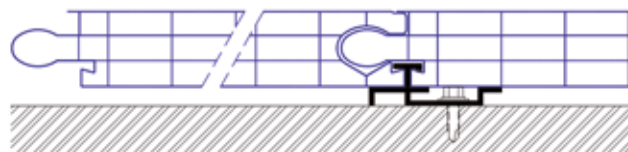
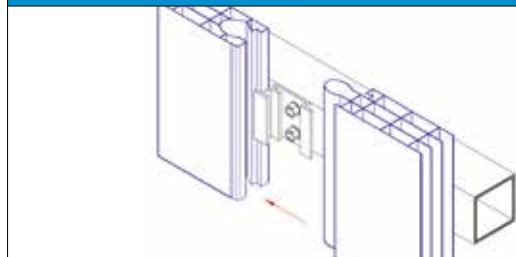

LLAVE DE FIJACIÓN

POLICARBONATO CORRUGADO

▶ POLICARBONATO GRAN ONDA - 0,9 MM.

CÓDIGO: 0021

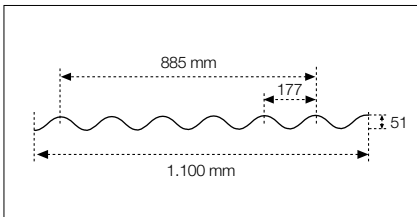

FICHA TÉCNICA	COLOR
	INCOLORO (TRANSPARENTE)
	OPAL (TRASLÚCIDO)

PRECIO €/M ²
14,60
15,15

STOCK CRISTAL **LONG.** 2500 - 3000 mm. OPAL **BAJO PEDIDO** **ANCHO** 1100 mm.

▶ POLICARBONATO MINIONDA - 0,8 MM.

CÓDIGO: 0021B

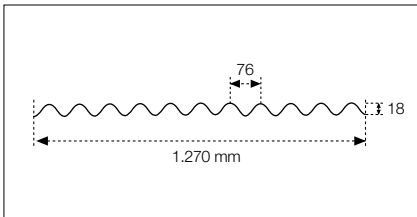

FICHA TÉCNICA	COLOR
	INCOLORO (TRANSPARENTE)
	OPAL (TRASLÚCIDO)

PRECIO €/M ²
12,40
12,85

STOCK CRISTAL **LONG.** 2500 - 3000 mm. OPAL **BAJO PEDIDO** **ANCHO** 1270 mm.

▶ POLICARBONATO TRAPEZIAL - 0,9 MM.

CÓDIGO: 0077

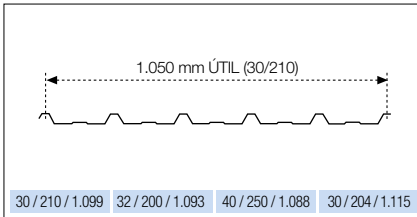

FICHA TÉCNICA	COLOR
	INCOLORO (TRANSPARENTE)
	OPAL (TRASLÚCIDO)

PRECIO €/M ²
14,30
14,85

STOCK CRISTAL **LONG.** 3000 - 6000 mm. (30 / 210) OPAL **LONG.** 3000 - 6000 mm. (30 / 210) **ANCHO** 1100 mm.

30 / 210 / 1.099 32 / 200 / 1.093 40 / 250 / 1.088 30 / 204 / 1.115

POLIÉSTER

▶ POLIESTER GRAN ONDA (GM01) - 0,8 MM.

CÓDIGO: 0020

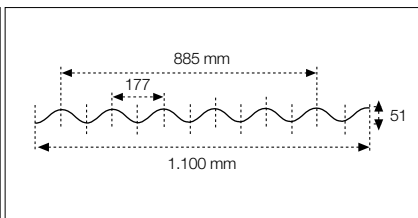

FICHA TÉCNICA



COLOR

CRISTAL

PRECIO €/M²

13,00

STOCK

CRISTAL

LONG. ▶

2000 - 2500 - 3000 mm.

OPAL

BAJO PEDIDO

ANCHO ▶

1100 mm.

▶ POLIESTER MINIONDA (GM02) - 0,8 MM.

CÓDIGO: 0020B

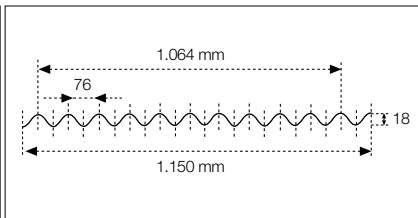

FICHA TÉCNICA



COLOR

CRISTAL

PRECIO €/M²

13,00

STOCK

CRISTAL

LONG. ▶

2000 - 2500 - 3000 mm.

OPAL

BAJO PEDIDO

ANCHO ▶

1150 mm.

▶ POLIESTER TRAPEZIAL - 1 MM.

CÓDIGO: 0076

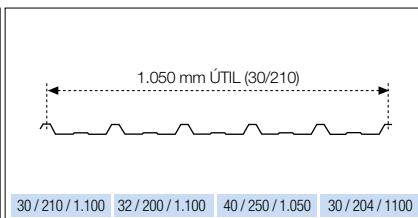

FICHA TÉCNICA



COLOR

CRISTAL

OPAL

PRECIO €/M²

15,00

STOCK

CRISTAL

LONG. ▶

3000 - 6000 mm. (30/210)

OPAL

LONG. ▶

3000 - 6000 mm. (30/210)

ANCHO ▶

1100 mm.

POLICARBONATO COMPACTO Y METACRILATO

► POLICARBONATO COMPACTO

CÓDIGO: 0028

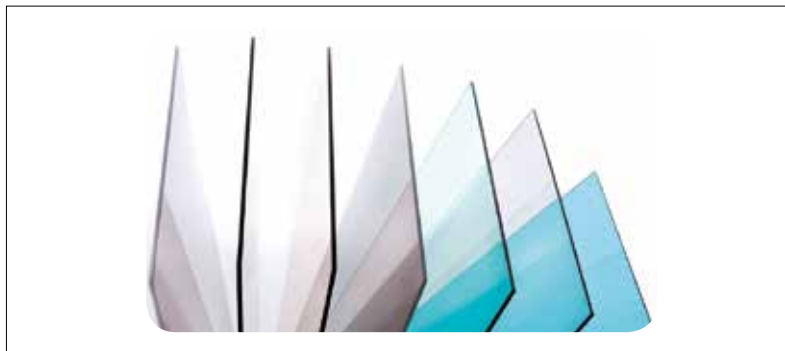

BAJO PEDIDO

MEDIDAS ESTÁNDAR: 3050 X 2050 mm.

ESPESOR (mm.)	COLOR	PRECIO €/M ²
3	INCOLORO	34,00
	OPAL	38,60
4	INCOLORO	45,35
	OPAL	51,50
5	INCOLORO	56,65
6	INCOLORO	67,95

► METACRILATO (COLADA)

CÓDIGO: 0029

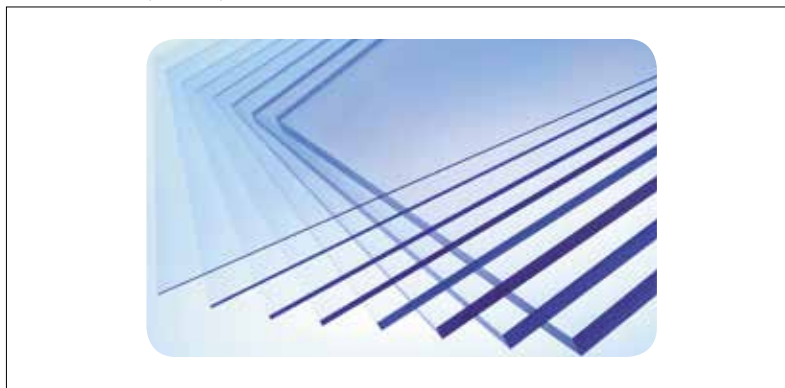

BAJO PEDIDO

MEDIDAS ESTÁNDAR: 3050 X 2030 mm. OTROS ESPEORES Y COLORES, CONSULTAR

ESPESOR (mm.)	COLOR	PRECIO €/M ²
3	INCOLORO	35,50
	OPAL	37,30
	COLOR	42,15
4	INCOLORO	45,20
	OPAL	47,45
5	INCOLORO	53,80
	OPAL	59,35
6	INCOLORO	64,55
	OPAL	71,20

LUCERNARIOS

LUCERNARIO TUBULAR - GLASS TOP

CÓDIGO: 0035



Nuestro sistema de lucernario tubular permite llevar **LUZ NATURAL** a espacios donde, mediante soluciones convencionales sería demasiado complejo o incluso imposible.

Se trata de un sistema que además del beneficio en clave de **AHORRO ENERGÉTICO**, resulta sencillo y rápido de instalar.

Los materiales que forman todos sus componentes, además, son de alta calidad. Doble vidrio con sistema climalit, tubos de aluminio, difusor de metacrilato, etc.

CAPTA-LUZ GLASS-TOP						
	DIÁMETRO					
	300 mm.			550 mm.		
	DIFUSOR			DIFUSOR		
	Residencial	Industrial		Residencial	Industrial	
No transitable	Estándar	Colgante	Oficinas	Estándar	Colgante	Oficinas
GLASS-TOP GTR1 - 600 mm.	450€	425€	595€	820€	750€	850€
GLASS-TOP GTR2 - 1.200 mm.	510€	485€	650€	934€	860€	960€
GLASS-TOP GTR3 - 2.400 mm.	630€	600€	775€	1160€	1090€	1190€
TRAMO ADICIONAL LONGITUD 600 MM.	70,00€			135,00€		
TWIST CODO 30°	100,00€			150,00€		
TWIST CODO 90°	295,00€			475,00€		
Eficacia Media	5 / 15 m ²			20 / 40 m ²		
Eficiencia Media / anual	120 / 250 Luxes			250 / 500 Luxes		

DETALLE DE INSTALACIÓN

- 1** Limpiar cúpula por interior y exterior
- 2** Colocar cúpula apoyada sobre manguito corona
- 3** Localizar el sur
- 4** Orientar la cúpula
- 5** Atornillar cúpula

LUCERNARIO TUBULAR - FLAT TOP

CÓDIGO: 0035B



Además de las propiedades descritas en el sistema Glasstop, el **FLAT-TOP** permite el tránsito tanto de personas como de vehículos* sobre él, gracias al triple vidrio reforzado del que está compuesto su captador de luz.

* Carga admisible sobre una superficie de 100x100 mm.: Q=1.000 kg.

CAPTA-LUZ FLAT-TOP						
	DIÁMETRO					
	300 mm.			550 mm.		
	DIFUSOR			DIFUSOR		
	Residencial	Industrial		Residencial	Industrial	
Transitable Peatonal / Vehículos ligeros	Estándar	Colgante	Oficinas	Estándar	Colgante	Oficinas
Flat.top FTR1 - 600 mm. - PEATONAL	1340€	1300€	1475€	2050€	1990€	2085€
Flat.top FTR1 - 600 mm. - VEHICULOS	1620 €	1610€	1750€	2565€	2500€	2595€
TRAMO ADICIONAL LONGITUD 600 MM.	70,00€			135,00€		
TWIST CODO 30°	100,00€			150,00€		
TWIST CODO 90°	295,00€			475,00€		
Eficacia Media	6 / 12 m ²			15 / 30 m ²		
Eficiencia Media / anual	100 / 300 Luxes			250 / 400 Luxes		

FICHAS TÉCNICAS



GLASS TOP



MANUAL MONTAJE GLASS TOP



FLAT TOP



MANUAL MONTAJE FLAT TOP

CLARABOYAS METACRILATO

CÓDIGO: 0030

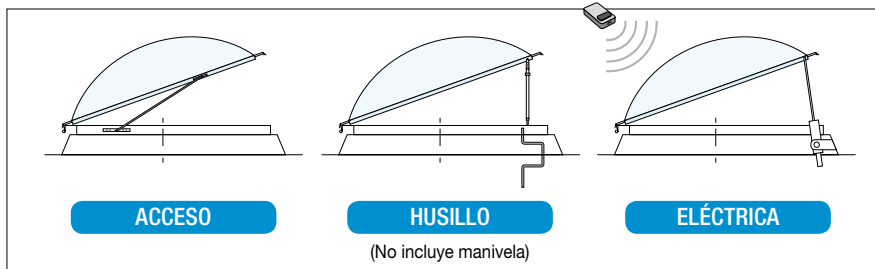
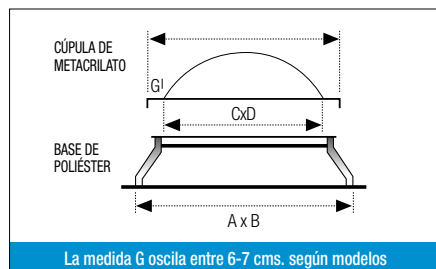

CUADRADAS

HUECO FORJADO Medida (AxB) en cm.	ENTRADA LUZ Medida (CxD) en cm.	Cúpulas sueeltas	CLARABOYAS FIJAS ZÓCALO + CÚPULA		CLARABOYAS CON SISTEMA DE APERTURA CON ZÓCALO P.R.F.V. Y CÚPULAS DE METACRILATO							
			Monovalva	Bivalva	APERTURA HUSILLO		APERTURA ACCESO		APERTURA ELÉCTRICA		A. ELÉCTRICA MANDO	
					Monovalva	Bivalva	Monovalva	Bivalva	Monovalva	Bivalva	Monovalva	Bivalva
50x50	30x30	34,00	96,00	129,00	212,00	242,00	***	***	585,00	614,00	810,00	838,00
60x60	40x40	43,00	107,00	150,00	227,00	266,00	215,00	253,00	598,00	634,00	856,00	883,00
70x70	50x50	55,00	124,00	179,00	255,00	305,00	253,00	303,00	604,00	650,00	861,00	907,00
80x80*	60x60	67,00	155,00	222,00	290,00	350,00	290,00	350,00	632,00	689,00	883,00	939,00
90x90*	70x70	81,00	165,00	245,00	332,00	405,00	305,00	378,00	650,00	719,00	895,00	964,00
100x100*	80x80	86,00	181,00	267,00	354,00	431,00	326,00	403,00	658,00	731,00	907,00	980,00
120x120*	100x100	124,00	248,00	372,00	429,00	540,00	427,00	538,00	715,00	820,00	988,00	1.093,00
130x130	110x110	158,00	286,00	443,00	472,00	613,00	487,00	628,00	822,00	956,00	1.081,00	1.215,00
140x140	120x120	188,00	322,00	510,00	515,00	684,00	545,00	714,00	929,00	1.089,00	1.174,00	1.334,00
150x150	130x130	234,00	393,00	627,00	590,00	800,00	558,00	768,00	992,00	1.190,00	1.227,00	1.425,00
160x160	140x140	284,00	441,00	724,00	641,00	896,00	600,00	855,00	1.039,00	1.280,00	1.306,00	1.547,00
170x170	150x150	417,00	631,00	1.048,00	868,00	1.243,00	***	***	1.144,00	1.498,00	1.399,00	1.753,00
180x180	160x160	369,00	536,00	905,00	911,00	1.243,00	***	***	1.251,00	1.565,00	1.411,00	1.725,00
200x200	180x180	462,00	605,00	1.067,00	1.061,00	1.477,00	***	***	1.294,00	1.686,00	1.425,00	1.818,00

PORTES

HASTA 1.000 x 1.000

25,00€

HASTA 1.500 x 1.500

50,00€

HASTA 2.000 x 2.000

75,00€

SUMAR AL COSTE DE LA CLARABOYA

* CORTINA OSCURECIMIENTO

450,00€

CLARABOYAS METACRILATO

RECTANGULARES

HUECO FORJADO Medida (AxB) en cm.	ENTRADA LUZ Medida (CxD) en cm.	Cúpulas sueitas	CLARABOYAS FIJAS ZÓCALO + CÚPULA		CLARABOYAS CON SISTEMA DE APERTURA CON ZÓCALO P.R.F.V. Y CÚPULAS DE METACRILATO							
			Monovalva	Bivalva	APERTURA HUSILLO		APERTURA ACCESO		APERTURA ELÉCTRICA		A. ELÉCTRICA MANDO	
					Monovalva	Bivalva	Monovalva	Bivalva	Monovalva	Bivalva	Monovalva	Bivalva
50x100*	30x80	50,00	141,00	191,00	266,00	311,00	243,00	288,00	601,00	644,00	840,00	883,00
60x80*	40x60	65,00	148,00	212,00	283,00	341,00	268,00	326,00	565,00	620,00	901,00	956,00
60x90*	40x70	55,00	141,00	196,00	288,00	337,00	245,00	294,00	606,00	652,00	846,00	893,00
60x100*	40x80	84,00	162,00	246,00	298,00	373,00	277,00	352,00	577,00	648,00	929,00	1.000,00
60x120*	40x100	93,00	200,00	293,00	363,00	446,00	341,00	425,00	664,00	743,00	1.018,00	1.097,00
60x200	40x180	141,00	250,00	391,00	620,00	746,00	448,00	575,00	962,00	1.081,00	1.356,00	1.476,00
70x100*	50x80	72,00	167,00	238,00	313,00	378,00	298,00	363,00	626,00	686,00	863,00	923,00
80x100*	60x80	98,00	205,00	303,00	335,00	423,00	326,00	414,00	624,00	707,00	937,00	1.020,00
80x110	60x90	108,00	219,00	327,00	352,00	448,00	339,00	435,00	672,00	763,00	950,00	1.041,00
80x120*	60x100	117,00	229,00	346,00	382,00	487,00	373,00	478,00	786,00	885,00	1.178,00	1.277,00
80x140*	60x120	131,00	262,00	393,00	455,00	573,00	427,00	545,00	919,00	1.030,00	1.312,00	1.423,00
90x120*	70x100	103,00	217,00	319,00	410,00	502,00	382,00	474,00	711,00	798,00	980,00	1.067,00
94x140*	74x120	172,00	324,00	496,00	536,00	690,00	418,00	573,00	873,00	1.018,00	1.265,00	1.411,00
100x150*	80x130	155,00	291,00	446,00	468,00	607,00	455,00	594,00	806,00	937,00	1.063,00	1.194,00
100x200	80x180	253,00	403,00	655,00	615,00	843,00	579,00	806,00	877,00	1.091,00	1.158,00	1.373,00
150x200	130x180	384,00	608,00	991,00	945,00	1.290,00	***	***	1.245,00	1.571,00	1.294,00	1.619,00
150x300	130x280	643,00	1.000,00	1.643,00	1.275,00	1.854,00	***	***	1.599,00	2.146,00	1.781,00	2.328,00
160x240	140x220	465,00	741,00	1.205,00	1.070,00	1.488,00	***	***	1.362,00	1.757,00	1.583,00	1.978,00
200x260	180x240	679,00	950,00	1.629,00	1.275,00	1.886,00	***	***	1.617,00	2.194,00	1.802,00	2.378,00
200x300	180x280	712,00	1.069,00	1.781,00	1.380,00	2.021,00	***	***	1.723,00	2.328,00	1.848,00	2.453,00

PORTES	HASTA 900 x 1.200	25,00€	HASTA 1.500 x 2.000	50,00€	HASTA 2.000 x 3.000	75,00€	SUMAR AL COSTE DE LA CLARABOYA
*	CORTINA OSCURECIMIENTO	500,00€					

CLARABOYAS METACRILATO

CIRCULARES

HUECO FORJADO Medida (AxB) en cm.	ENTRADA LUZ Medida (CxD) en cm.	Cúpulas sueitas	CLARABOYAS FIJAS ZÓCALO + CÚPULA		CLARABOYAS CON SISTEMA DE APERTURA CON ZÓCALO P.R.F.V. Y CÚPULAS DE METACRILATO							
					APERTURA HUSILLO		APERTURA ACCESO		APERTURA ELÉCTRICA		A. ELÉCTRICA MANDO	
			Monovalva	Bivalva	Monovalva	Bivalva	Monovalva	Bivalva	Monovalva	Bivalva	Monovalva	Bivalva
60	40	48,00	105,00	153,00	405,00	448,00	***	***	778,00	818,00	1.077,00	1.118,00
70	50	58,00	127,00	184,00	448,00	499,00	***	***	786,00	834,00	1.093,00	1.142,00
80	60	72,00	172,00	243,00	499,00	564,00	***	***	818,00	879,00	1.120,00	1.180,00
90	70	115,00	203,00	317,00	564,00	667,00	***	***	840,00	937,00	1.134,00	1.231,00
100	80	91,00	200,00	291,00	596,00	678,00	***	***	850,00	927,00	1.150,00	1.227,00
110	90	153,00	277,00	429,00	686,00	823,00	***	***	911,00	1.041,00	1.190,00	1.320,00
120	100	127,00	248,00	374,00	***	***	***	***	***	***	***	***
130	110	224,00	524,00	748,00	***	***	***	***	***	***	***	***
140	120	272,00	531,00	803,00	***	***	***	***	***	***	***	***
150	130	248,00	448,00	696,00	***	***	***	***	***	***	***	***
180	160	405,00	712,00	1.117,00	***	***	***	***	***	***	***	***
200	180	441,00	674,00	1.115,00	***	***	***	***	***	***	***	***

Manivela lacada blanco de 1,5 m.	30,00 €/u.	Motor eléc. de 180mm. de recorrido	385,00 €/u.	Husillo simple para claraboya	105,00 €/u.
----------------------------------	-------------------	------------------------------------	--------------------	-------------------------------	--------------------

GM CLARABOYAS PANEL TEJA

HUECO FORJADO Medida (AxB) en cm.	ENTRADA LUZ Medida (CxD) en cm.	Cúpulas sueitas	CLARABOYAS FIJAS ZÓCALO + CÚPULA		CLARABOYAS CON SISTEMA DE APERTURA CON ZÓCALO P.R.F.V. Y CÚPULAS DE METACRILATO							
					APERTURA HUSILLO		APERTURA ACCESO		APERTURA ELÉCTRICA		A. ELÉCTRICA MANDO	
			Monovalva	Bivalva	Monovalva	Bivalva	Monovalva	Bivalva	Monovalva	Bivalva	Monovalva	Bivalva
70x70	50x50	55,00	327,00	381,00	414,00	463,00	401,00	450,00	672,00	719,00	935,00	982,00

PORTES

HASTA 1.000

25,00€

HASTA 1.500

50,00€

HASTA 2.000

75,00€

CLARABOYA TEJA

35,00€

SUMAR AL COSTE DE LA CLARABOYA

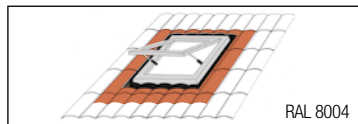

Nota importante: sólo compatible con nuestro panel imitación teja

SISTEMAS DE VENTILACIÓN



EXTRACTOR EÓLICO BÁSICO

Sistema de ventilación sin consumo eléctrico

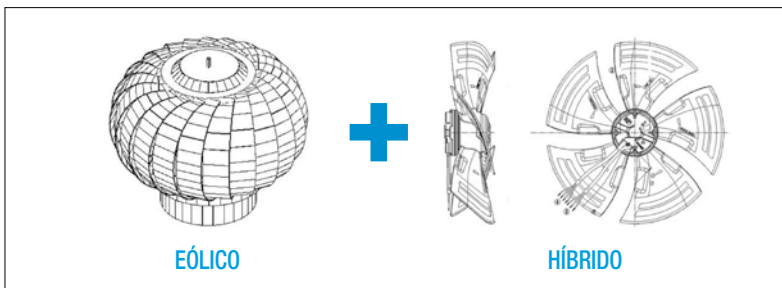

EÓLICO

HÍBRIDO

EXTRACTOR EÓLICO HÍBRIDO

A partir del sistema básico, se incorpora un electroventilador con un consumo mínimo de energía.

EXTRACTOR BÁSICO				EXTRACTOR HÍBRIDO				BASE INDUSTRIAL							
10"- (250mm)		14"- (350mm)		16"- (400mm)		20"- (500mm)		16"- (400mm)		20"- (500mm)		10"	14"	16"	20"
€/ud.	360	€/ud.	495	€/ud.	560	€/ud.	835	€/ud.	1.225	€/ud.	1.410	180	180	180	200
841m³/h*		1649m³/h*		2153m³/h*		3365m³/h*		3000m³/h**		4275m³/h**		* (Extracción: 15 km/h) ** (Extracción: 0 km/h)			

EXUTORIOS

Sistemas automáticos de EVACUACIÓN de calor, humo y gases en caso de incendio.





BAJO PEDIDO

CONSULTAR

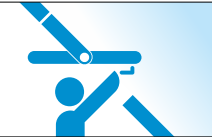

VENTANAS *ROTO*

CÓDIGO: 0046

STOCK

PIVOTANTE (R4)	ACABADO INTERIOR	MEDIDA (código)	ANCHO X LARGO (cm)	PVP	TAPAJUNTAS ONDULADO	CORTINA BLANCA	CORTINA CREMA	
				€/ud.				
	MADERA	5/7	54x78	229	70	-	82	
	MADERA	5/9	54x98	244	71	-	82	
	MADERA	7/6	74x60	273	78	-	92	
	MADERA	7/9	78x98	275	78	-	96	
PROYECTANTE (R7)	ACABADO INTERIOR	MEDIDA (código)	ANCHO X LARGO (cm)	PVP	TAPAJUNTAS ONDULADO	CORTINA BLANCA	CORTINA CREMA	
				€/ud.				
	MADERA	5/7	54x78	288	70	-	82	
	MADERA	5/9	54x98	314	71	-	82	
	MADERA	7/9	78x98	354	78	-	86	
	PVC	5/7	54x78	325	70	82	-	
	PVC	5/9	54x98	356	71	82	-	
	PVC	7/9	78x98	391	78	86	-	

STOCK

LUCERA WDL210	ACABADO INTERIOR	MEDIDA (código)	ANCHO X LARGO (cm)	PVP	LUCERA WDL210	VENTANA APERTURA LATERAL - R3
				€/ud.		
	MADERA	4/5	45X55	147		
	MADERA	4/7	45X73	154		
VENTANA APERTURA LATERAL DERECHA (R3)	ACABADO INTERIOR	MEDIDA (código)	ANCHO X LARGO (cm)	PVP		
				€/ud.		
	MADERA	7/9	78X98	560		
VENTANA PARA PANEL TAPAJUNTAS**	ACABADO INTERIOR	MEDIDA (código)	ANCHO X LARGO (cm)	PVP		
				€/ud.		
	PVC	5/9	54X98	450		

MANIVELA ZUB 1 170 - 1920	PVP
	€/ud.
	38

** (VENTANA ADAPTABLE A NUESTRO PANEL TAPAJUNTAS)





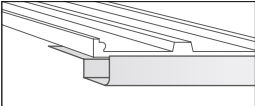
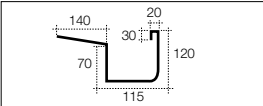
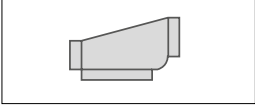
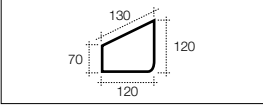
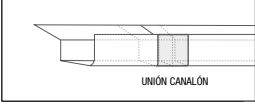
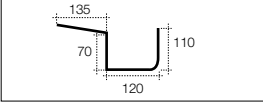
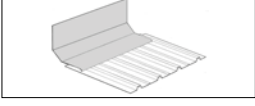
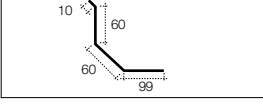
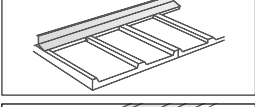
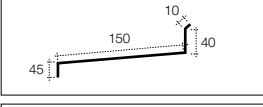
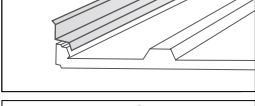
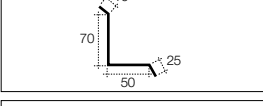
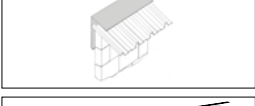
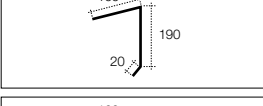
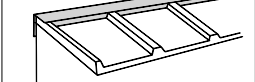
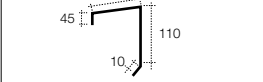





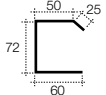

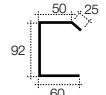
REMATERÍA ESTÁNDAR

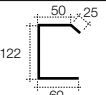
CÓDIGO: 0046

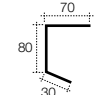

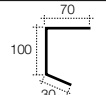

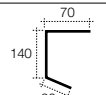
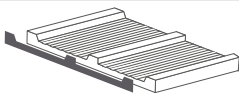
			ESPESOR	COLOR	LONG. (MM.)	PRECIO €/UD	
CANALES	Remate Canalón			0,6	BP RT 7022 NEGRO	1.500 3.000	14,80 29,60
	Remate Tapa Canalón			0,6	BP RT 7022 NEGRO	PAREJA	20,50
	Remate Collarín Canalón	 UNIÓN CANALÓN		0,6	BP RT 7022 NEGRO	UNIDAD	6,50
ENTREGAS	Remate Entrega Trasera a pared			0,6	BP RT	1.500 3.000	8,75 17,50
	Remate Trasera troquelada TPJ			0,6	BP RT 7022 NEGRO	2.100	17,75
	Remate Entrega Lateral a pared			0,6	BP RT 7022 NEGRO	1.500 3.000	5,60 11,20
	Remate Testa Superior			0,6	BP RT	1.500 3.000	9,90 19,80
	Remate Testa Superior Troquelada			0,6	BP RT 7022 NEGRO	2.100	17,75

ACCESORIOS

REMATERÍA ESTÁNDAR

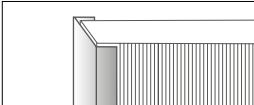
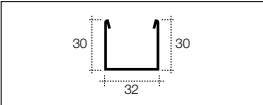
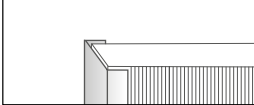
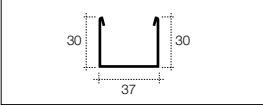
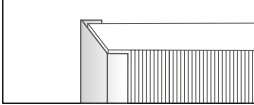
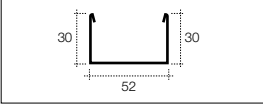
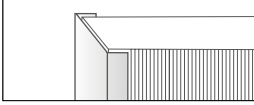
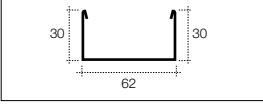
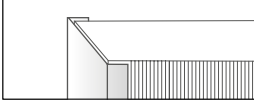
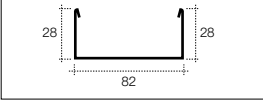
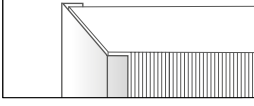
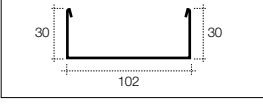
			ESPESOR	COLOR	LONG. (MM.)	PRECIO €/UD	
LATERALES	Remate Lateral 30			0,6	BP RT 7022	1.500 3.000	6,60 13,20
	Remate Lateral 50			0,6	BP NEGRO	1.500 3.000	8,75 17,50
	Remate Lateral 80			0,6	BP	1.500 3.000	9,90 19,80
FRONTALES	Remate Frontal Simple 30			0,6	BP RT	1.500 3.000	6,60 13,20
	Remate Frontal Simple 50			0,6	BP	1.500 3.000	8,75 17,50
	Remate Frontal Simple 80			0,6	BP	1.500 3.000	8,75 17,50
	Remate Tapa Frontal 30/50/80			0,6	BP (30/50/80) RT (30) 7022 (30) NEGRO (50)	1.000	9,75

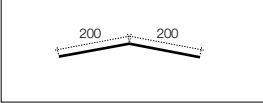
REMATERÍA ESTÁNDAR

			ESPESOR	COLOR	LONG. (MM.)	PRECIO €/UD	
CIERRES	Remate Cierre 30			0,6	BP	1.500 3.000	5,00 10,00
	Remate Cierre 35			0,6	BP	1.500 3.000	5,00 10,00
	Remate Cierre 50			0,6	BP	1.500 3.000	5,00 10,00
	Remate Cierre 60			0,6	BP	1.500 3.000	5,00 10,00
	Remate Cierre 80			0,6	BP	1.500 3.000	5,60 11,20
	Remate Cierre 100			0,6	BP	1.500 3.000	6,60 13,20
CUMBRERAS	Remate Cumbreira Simple			0,6	BP RT	1.500 3.000	11,85 23,70
	Remate Cumbreira Troquelada			0,6	BP RT 7022 NEGRO	2.100	29,60

ACCESORIOS

REMATERÍA ESTÁNDAR

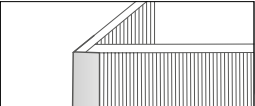
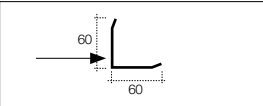
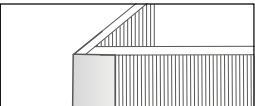
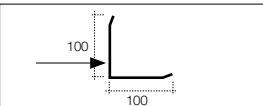
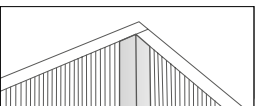
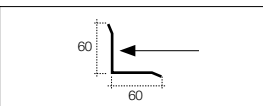
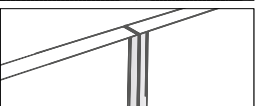
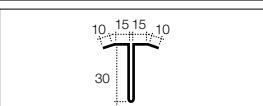
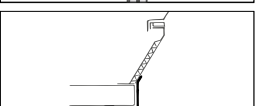
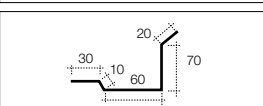
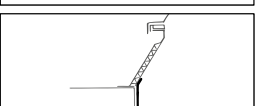
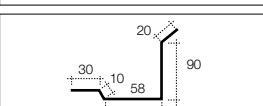
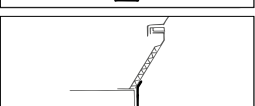
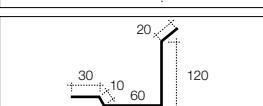
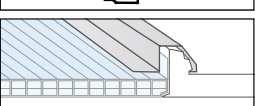
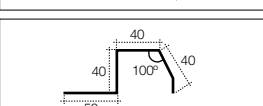
			ESESOR	COLOR	LONG. (MM.)	PRECIO €/UD	
ÁNGULOS	Remate Esquinero Exterior 60x60			0,6	BP	1.500 3.000	5,00 10,00
	Remate Esquinero Exterior 100x100			0,6	BP	1.500 3.000	6,60 13,20
	Remate Esquinero Interior 60x60			0,6	BP	1.500 3.000	5,00 10,00
OTROS	Remate Unión Fachada "T"			0,6	BP	1.500 3.000	6,60 13,20
	Remate Interior Claraboya 30 (Panel 30)			0,6	BP	1.500 3.000	6,60 13,20
	Remate Interior Claraboya 50 (Panel 50)			0,6	BP	1.500 3.000	6,60 13,20
	Remate Interior Claraboya 80 (Panel 80)			0,6	BP	1.500 3.000	8,75 17,50
	Remate Unión Lucernario - TPJ			0,6	BP RT 7022 NEGRO	1.500 3.000	6,60 13,20

REMATERÍA PANEL TEJA

CÓDIGO: 0038

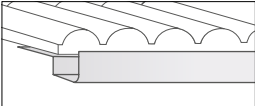
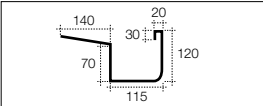
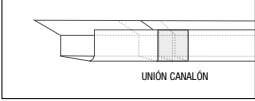
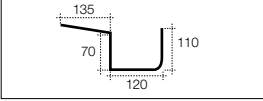
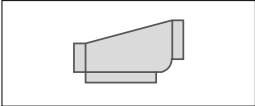
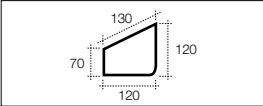
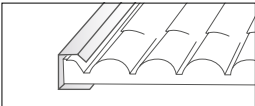
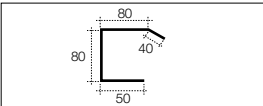
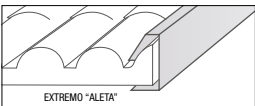
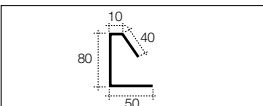
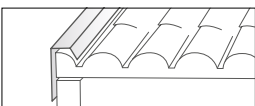
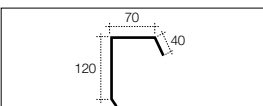
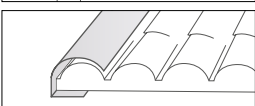
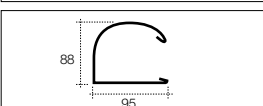
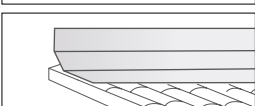
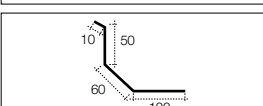
			ESPESOR	COLOR	MEDIDAS	PRECIO €/UD	
CANALES	Remate Canalón Teja			0,6	8004	1.500 3.000	18,15 36,30
					GRIS PIZARRA ENVEJECIDO	1.500 3.000	20,65 41,30
	Remate Collarín de unión canalón Teja			0,6	8004	UNIDAD	6,50
					GRIS PIZARRA ENVEJECIDO	UNIDAD	6,50
	Remate Tapa Canalón Teja			0,6	8004	PAREJA	20,50
					GRIS PIZARRA ENVEJECIDO	PAREJA	20,50
LATERALES	Remate Lateral Teja			0,6	8004	1.500 3.000	11,40 22,80
					GRIS PIZARRA ENVEJECIDO	1.500 3.000	11,85 23,70
	Remate Lateral Pestaña Teja			0,6	8004	1.500	10,45
						3.000	20,90
	Remate Lateral Recto Teja			0,6	8004	1.500	11,40
						3.000	22,80
Remate Lateral Redondo Teja			0,6	8004	1.500	14,25	
					3.000	28,50	
ENTREGAS	Remate Entrega Trasera a pared Teja			0,6	8004	1.500	11,40
						3.000	22,80

ACCESORIOS

REMATERÍA PANEL TEJA

				ESPESOR	COLOR	MEDIDAS	PRECIO €/UD
ENTREGAS	Remate Entrega Lateral a pared Teja			0,6	8004	1.500 3.000	10,45 20,90
					GRIS PIZARRA ENVEJECIDO	1.500 3.000	10,90 21,80
	Remate Pared Trasera Troquelada Teja			0,6	8004	2.060	23,70
GRIS PIZARRA ENVEJECIDO					2.060	24,70	
Remate Testa Superior Teja			0,6	8004	1.500	12,80	
					3.000	25,60	
FRONTALES	Remate Tapa Frontal Teja			0,6	8004	1.000	10,80
					GRIS PIZARRA ENVEJECIDO	1.000	11,25
FRONTALES	Remate Frontal Simple Teja			0,6	8004	1.500 3.000	10,45 20,90
					GRIS PIZARRA ENVEJECIDO	1.500 3.000	10,90 21,80
CUMBRERAS	Remate Cumbre Simple Teja			0,6	8004	1.500	15,10
						3.000	30,20
CUMBRERAS	Remate Cumbre Troquelada Teja			0,6	8004	2.060	55,40
					GRIS PIZARRA ENVEJECIDO	2.060	30,20
OTROS	Remate Unión Lucernario - Teja			0,6	8004	1.500	11,40
						3.000	22,80

€/ml	REMATES DE ACERO GALVANIZADO										
Esp./Desarrollo*	125	156	208	250	312	416	500	625	750	1.000	1.250
0,60	2,60	2,80	3,20	4,35	4,80	5,60	6,20	7,95	8,90	10,80	12,70
0,80	2,85	3,20	3,70	4,90	5,50	6,55	7,35	9,40	10,65	13,10	15,55
1,00	3,20	3,60	4,25	5,55	6,30	7,65	8,65	11,05	12,60	14,70	18,80
1,20	3,50	3,95	4,75	6,20	7,10	8,65	9,90	12,60	14,45	18,20	21,90
1,50	4,45	5,15	6,35	8,10	9,50	11,85	13,80	17,40	20,25	25,90	31,55
2,00	5,35	6,25	7,80	9,85	11,70	14,80	17,25	21,75	25,50	32,90	40,30
€/ml	REMATES DE ACERO PRELACADO										
0,60	3,10	3,45	4,05	5,35	6,10	7,30	8,30	10,55	12,00	14,95	17,85
0,80	3,60	4,05	4,85	6,35	7,30	8,90	10,25	13,00	14,95	18,85	22,70
1,00	4,00	4,60	5,60	7,15	8,35	10,30	11,90	15,05	17,45	22,15	26,90
Teja 0,6	3,95	4,45	5,25	6,85	7,80	9,35	10,60	13,50	15,35	19,10	22,85
Imit. Madera 0,6	3,95	4,45	5,25	6,85	7,80	9,35	10,60	13,50	15,35	19,10	22,85

BAJO PEDIDO

A MEDIDA

* Desarrollo: Suma de las cotas en milímetros

CHAPA LISA DE ACERO		€/m ²	€/UD
CHAPA LISA BLANCO PIRINEO	3.000 x 1.250 x 0,6	12,10 €	45,40 €
CHAPA LISA ROJO TEJA	3.000 x 1.250 x 0,6	12,10 €	45,40 €
CHAPA LISA TEJA 8004	3.000 x 1.250 x 0,6	18,65 €	70,00 €
CHAPA LISA ENVEJECIDA	3.000 x 1.250 x 0,6	20,00 €	75,00 €
CHAPA LISA IMITACIÓN MADERA	3.000 x 1.070 x 0,6	23,40 €	75,00 €

STOCK

! TODOS NUESTROS REMATES EN CHAPA 0,6 MM.

POLICARBONATO / ACCESORIOS







CÓDIGO: 0040

Perfil TAPETA Aluminio		ACABADO	€/ML		ESPESOR	€/ML
		ANODIZADO PLATA LACADO BLANCO	3,60 3,40			4/6 8/10 16 25
MEDIDAS	3.000 - 6.000 mm.			MEDIDAS	3.000 - 6.000 mm.	
Perfil Universal GLASSLUX Aluminio		ACABADO	€/ML		ESPESOR	€/UD
		ANODIZADO PLATA LACADO BLANCO	5,40 5,20			4/6 8/10 16
MEDIDAS	3.000 - 6.000 mm.			CONJUNTO	TAPÓN+JUNTA+FIJACIÓN	
Goma UÑA Aleta		€/UD	€/ML		ACABADO	€/UD
		90,00	0,75			BLANCO PIRINEO
MEDIDAS	ROLLO: 120 ML			MEDIDAS	3.000 mm.	
Goma BASE Estándar		€/UD	► €/ML		ACABADO	€/UD
		132,00	2,20			ANODIZADO PLATA
MEDIDAS	ROLLO: 60 ML			UNIDAD	-	
Goma base PATAS		€/UD	€/ML		ANCHO	€/UD
		105,00	3,50			25 38
MEDIDAS	ROLLO: 30 ML			UNIDAD	ROLLO: 33 ML	
Perfil Cierre en U Policarbonato		ESPESOR	€/ML		ANCHO	€/UD
		4/6 8/10 16 25	1,10 1,35 1,50 2,95			25 38 62
MEDIDAS	2.100 mm.			UNIDAD	ROLLO: 50 ML	

GMSISTEMA EVACUACIÓN AGUAS - PVC

CÓDIGO: 0042













ACCESORIOS

GMCanal Redondeado		COLOR	€/UD
		BLANCO	19,50
MEDIDAS		4.000 mm.	
GMCanal Unión con descarga		COLOR	€/UD
		BLANCO	4,95
UNIDAD		-	
GMJunta Interna		COLOR	€/UD
		BLANCO	2,40
UNIDAD		-	
GMTapa Canal redondeado		COLOR	€/UD
		BLANCO	1,90
UNIDAD		-	
GMTapa Unión con descarga		COLOR	€/UD
		BLANCO	1,10
UNIDAD		-	
GMAngular Canal redondeado		COLOR	€/UD
		BLANCO	5,50
UNIDAD		-	

GMCodo 87° 30' Tubo 80		COLOR	€/UD
		BLANCO	3,70
UNIDAD		-	
GMCodo 67° 30' Tubo 80		COLOR	€/UD
		BLANCO	2,70
UNIDAD		-	
GMTubo redondo ø 80		COLOR	€/UD
		BLANCO	21,90
MEDIDAS		3.000 mm.	
GMCollar para tubo 80		COLOR	€/UD
		BLANCO	2,50
UNIDAD		-	
GMSoporte para falda		COLOR	► €/UD ◀
		-	0,95
UNIDAD		-	
GMSoporte para pared		COLOR	► €/UD ◀
		BLANCO	1,50
UNIDAD		-	







GMSISTEMA EVACUACIÓN AGUAS - PVC



CÓDIGO: 0101

GMCanal Redondeado		COLOR	€/UD		COLOR	€/UD
		BRONCE OSCURO	25,35		BRONCE OSCURO	7,70
MEDIDAS	3.000 mm.			UNIDAD	-	
GMCanal Unión con descarga		COLOR	€/UD		COLOR	€/UD
		BRONCE OSCURO	17,40		BRONCE OSCURO	6,05
UNIDAD	-			UNIDAD	-	
GMJunta Interna		COLOR	€/UD		COLOR	€/UD
		BRONCE OSCURO	4,05		BRONCE OSCURO	19,05
UNIDAD	-			MEDIDAS	3.070 mm.	
GMTapa Canal redondeado		COLOR	€/UD		COLOR	€/UD
		BRONCE OSCURO	5,00		BRONCE OSCURO	3,85
UNIDAD	-			UNIDAD	-	
GMTapa Unión con descarga		COLOR	€/UD		COLOR	€/UD
		BRONCE OSCURO	5,55		NEGRO	5,50
UNIDAD	-			UNIDAD	-	
GMAngular Canal redondeado		COLOR	€/UD		COLOR	€/UD
		BRONCE OSCURO	13,65		NEGRO	5,50
UNIDAD	-			UNIDAD	-	

GMSISTEMA EVACUACIÓN AGUAS - ACERO

CÓDIGO: 0102

GMCanal Metálico Redondeado des. 280		COLOR	€/UD
		BLANCO MARRÓN	24,90
MEDIDAS	3.000 mm.		
GMCanal Unión Metálica con descarga		COLOR	€/UD
		BLANCO MARRÓN	10,35
UNIDAD	-		
GMTapa Canal Metálica ajuste rápido		COLOR	€/UD
		BLANCO MARRÓN	2,80
UNIDAD	-		
GMTubo Metálico Redondo Engatillado diam. 80		COLOR	€/UD
		BLANCO MARRÓN	27,20
MEDIDAS	3.000 mm.		
GMCollar Metálico para tubo 80		COLOR	€/UD
		BLANCO MARRÓN	2,25
UNIDAD	-		
GMManguito Unión Metálico tubo 80		COLOR	€/UD
		BLANCO MARRÓN	7,15
UNIDAD	-		

GMCodo 72° Metálico Engatillado Tubo 80		COLOR	€/UD
		BLANCO MARRÓN	4,60
UNIDAD	-		
GMSoporte para falda <small>REQUIERE GMSOPORTE PARED PARA FIJARSE A LA CANAL</small>		COLOR	€/UD
		GALVA	0,95
UNIDAD	-		
GMSoporte Pared Metálico pletina doble lengüeta		COLOR	€/UD
		BLANCO MARRÓN	4,50
UNIDAD	-		

ACCESORIOS

GM ACCESORIOS FRIGORÍFICO

CÓDIGO: 0053

Perfil Sanitario esquinero interior 90 mm.		COLOR	€/ML
		BLANCO	2,35

TIPO	290P PVC
------	----------

MEDIDAS	4.000 MM.
---------	-----------

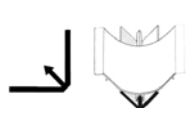
Perfil Sanitario ángulo de fijación Aluminio 25x25 mm.		COLOR	€/ML
		BLANCO	1,75

TIPO	315P PVC
------	----------

MEDIDAS	4.000 MM.
---------	-----------

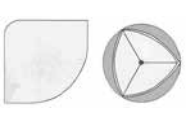
Perfil Sanitario unión esquinera		COLOR	€/UD
		BLANCO	1,95

TIPO	295 PVC
------	---------

UNIDAD	-
--------	---

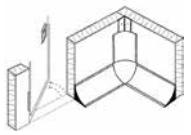
Perfil Sanitario tapa esquinero interior		COLOR	€/UD
		BLANCO	2,10

TIPO	288 PVC
------	---------

UNIDAD	-
--------	---

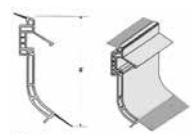
Perfil Sanitario zócalo		COLOR	€/ML
		BLANCO	5,50

TIPO	293 PVC
------	---------

MEDIDAS	3.000 MM.
---------	-----------

Perfil Sanitario esquina interior zócalo		COLOR	€/UD
		BLANCO	2,70

TIPO	296I PVC
------	----------

UNIDAD	-
--------	---

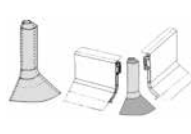
Perfil Sanitario esquina exterior zócalo		COLOR	€/UD
		BLANCO	2,70

TIPO	340E PVC
------	----------

UNIDAD	-
--------	---

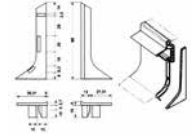
Perfil Sanitario Tapas zócalo		COLOR	€/UD
		BLANCO	1,05

TIPO	297 PVC
------	---------

UNIDAD	-
--------	---

GM ACCESORIOS FRIGORÍFICO

Bulón Chino M-10		COLOR	€/UD
		BLANCO	1,50

TIPO	-
UNIDAD	-

Perfil Soporte Techo Aluminio		COLOR	€/ML
		BLANCO	16,50

TIPO	-
MEDIDAS	4.000 MM.

Perfil Varilla Fijación para Soporte Techo		COLOR	€/UD
		GALVA	5,25

TIPO	-
UNIDAD	-

Perfil Tensor para Soporte Techo		COLOR	€/UD
		GALVA	4,95

TIPO	-
UNIDAD	-

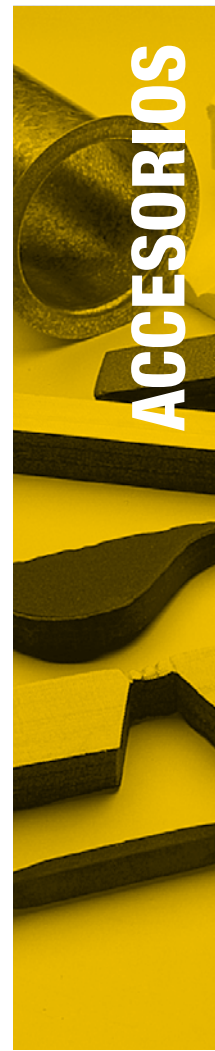
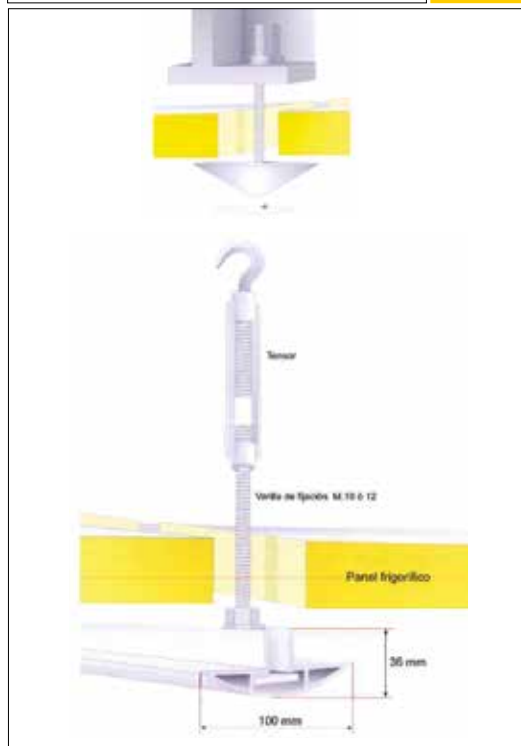

Varilla roscada métrica 10 (1.000 mm)	€/UD
	1,25

Unión hexagonal para varilla	€/UD
	0,20



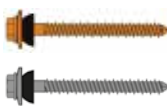

FIJACIONES

CÓDIGO: 0044

TORNILLOS	Tornillo Zincado Autorroscante		ACABADO	MEDIDAS	€/UD
			ZINCADO	6,3X25+P18 6,3X40+P18 6,3X50+P18 6,3X60+P18 6,3X80+P18 6,3X100+P18 6,3X120+P18	0,15 0,16 0,17 0,20 0,21 0,22 0,28
LLAVE DE VASO	10	BROCA	4mm (DE 1A 2mm) / 5,05mm (DE 2 A 2,9mm)		
TORNILLOS	Tornillo Zincado Autotaladrante (VIGA)		ACABADO	MEDIDAS	€/UD
			ZINCADO	5,5X38+P16 5,5X75XP16 5,5X105+P16 5,5X115+P16	0,20 0,35 0,40 0,50
LLAVE DE VASO	8	CAPACIDAD DE TALADRO	ENTRE 4 Y 12mm		
TORNILLOS	Tornillo Teja		ACABADO	MEDIDAS	€/UD
			8004	6,3X120+P25 EPDM-AR 6,3X120+P25 EPDM-AT	0,80
			PIZARRA	6,3X120+P25 EPDM-AR 6,3X120+P25 EPDM-AT	0,80
AR.: AUTORROSCANTE / AT.: AUTOTALADRANTE					
LLAVE DE VASO	10	BROCA	4mm (DE 1A 2mm) / 5,05mm (DE 2 A 2,9mm)		

ARANDELAS Y TAPONES	Arandelas		ACABADO	DESCRIPCIÓN	€/UD
			BLANCO	P14 BLANCA (VIPS)	0,10
			GALVA	P18 P25 Doble Estanq. Gran Onda Mini Onda	0,10 0,20 0,20 0,20
	Taponos		COLORES	CABEZA HEXAGONAL	0,12

TORNILLOS	Tornillo Zincado Autotaladrante		ACABADO	MEDIDAS	€/UD
			ZINCADO	6,3X25+P18 6,3X40+P18 6,3X50+P18 6,3X60+P18 6,3X80+P18 6,3X100+P18 6,3X120+P18 6,3X200	0,15 0,16 0,17 0,20 0,21 0,22 0,28 0,95
LLAVE DE VASO	10	CAPACIDAD DE TALADRO	ENTRE 2 Y 6mm		
TORNILLOS	Tornillo Hormigón		ACABADO	MEDIDAS	€/UD
			AZUL	6,5X32+P16 6,5X57+P16 6,5X100+P16 6,5X125+P16	0,18 0,20 0,35 0,45
LLAVE DE VASO	8	FIJACIÓN MÍNIMA EN EL HORMIGÓN (MACIZO)	25mm		
TORNILLOS	Tornillo Cosido Chapa		ACABADO	MEDIDAS	€/UD
			BLANCO	4,2X14 AT PLANA 4,2X14 AR-HEXAGONAL	0,20
			BLANCO PIRINEO ROJO TEJA VERDE NAVARRO	6,3X25 NYLON-AR 6,3X25 NYLON-AT	0,20
AR.: AUTORROSCANTE / AT.: AUTOTALADRANTE					
LLAVE DE VASO					11

OTROS		DESCRIPCIÓN	€/UD
		GANCHO DE FIJACIÓN 52X150MM	0,50
SOPORTE DE ONDA POLIPROPILENO OG	0,25		
SOPORTE DE ONDA POLIPROPILENO MO	0,35		
SOPORTE CANALÓN CUBIERTA 30MM	1,20		
SOPORTE CANALÓN CUBIERTA 50MM	1,40		

SISTEMAS DE PEGADO Y SELLADO

CÓDIGO: 0043

		COLOR	MEDIDA	PRECIO €/UD/ML
	GM Impac	Sistema de impermeabilización acrílica	BLANCO GRIS TEJA	5 KG. 19,50
	GM Impol	Sistema de impermeabilización en Poliuretano	BLANCO GRIS TEJA TEJA	6 KG. 6 KG. 1 KG. 6 KG. 39,80 7,50 39,80
	GM Imper PS	Pasta para sellado bituminosa	NEGRO	1 KG. 10,50
	GM Imper M1000	Malla para armado - ancho 1000mm	-	ML. 2,05
	GM Imper M170	Malla para armado - ancho 170mm	-	ML. 0,50
	GM Imper DX	Disolvente Xileno	-	5 KG. 18,50
	GM Imper IE	Imprimación Epoxi	-	2 KG. 25,50
	GM Imper BP	Barniz en poliuretano	-	4 KG. 53,10

ACCESORIOS

		€/UD			€/UD
Sellantes y adhesivos		Silicona neutra (incolora y blanca) 3,65 Masilla poliuretano (Blanca y Marrón) 5,65 Polímero (incolore) 6,50 Adhesivo alto agarre (Blanco) 6,50 Sell. acrílico resistente al fuego EI240 6,50		Cinta Butilo alum. (10mx100mm) 22,70 Cinta Butilo Blanca. (10mx100mm) 24,00 Cinta Butilo Roja. (10mx100mm) 24,00 Cinta Butilo 8004. (10mx100mm) 24,00 Cinta Butilo Terracota. (5mx200mm) 24,00 Cordón de butilo (7,5ml) 5,70 Imprimación para butilo 13,50	
Espumas de Poliuretano		Espuma poliuretano-estándar 6,25 Espuma poliuretano -fijación tejas 6,25			

VARIOS

Bocas Bajante galvanizadas		TUBO	€/UD
		80	8,55
		90	9,60
		110	12,65
		125	14,00

TIPO	-
MEDIDAS	70-84-104-114

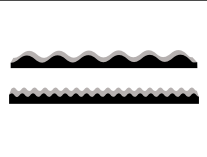
Junta estanca		COLOR	€/UD
		NEGRO	1,50

TIPO	MINIONDA - GRAN ONDA - 30/210 CM. - CONSULTAR
MEDIDAS	1.000 M

Retén Tubo 75 a 160°		COLOR	€/UD
		NEGRO	48,50

TIPO	NEGRO
UNIDAD	-

Trampilla acceso cubierta		COLOR	€/UD
		GALVANIZADO	315,00

TIPO	-
MEDIDAS	600 X 600 MM.

Pintura Spray retoques		COLOR	€/UD
		BLANCO PIRINEO ROJO TEJA RAL 8004	20,50

TIPO	-
UNIDAD	400 ML

Pintura tapas Panel Sandwich		COLOR	€/UD
		BLANCO PIRINEO ROJO TEJA RAL 8004	22,75

TIPO	-
UNIDAD	800 ML

ESTRUCTURA LIGERA

		ESPESOR (mm.)	LONGITUD (mm.)	€/UD
Omega 30 Galva.		0,6	6000	9,60
Correa Z-175 (Negro)		2,5	6000	39,50
Correa Z-200 (Negro)		2,5	6000	51,30

		ESPESOR (mm.)	LONGITUD (mm.)	€/UD
Omega 40 Galva.		0,7	6000	10,80
Tubo 50x50 (Galva)		2	6000	24,90
Tubo 60x40 (Negro)		2	6000	19,50

PIEZAS ÚNICAMENTE COMPATIBLES CON TUBO DE 50X50MM.		ACABADO	€/UD
Pza. Unión pared pendiente		GALVA	4,80
Pza. Arranque recto		GALVA	8,55
Pza. Unión "T" 4 partes recto		GALVA	17,80
Pza. Unión "T" 3 partes recto		GALVA	17,10

PIEZAS ÚNICAMENTE COMPATIBLES CON TUBO DE 50X50MM.		ACABADO	€/UD
Pza. Unión "T" 4 partes con pendiente		GALVA	13,70
Pza. Unión "L" delantera derecha con pendiente		GALVA	14,50
Pza. Unión "L" delantera izquierda con pendiente		GALVA	14,50

OTRAS PIEZAS Y PERFILES, CONSULTAR

ACCESORIOS

ALMACÉN IRONLUX GROUP 2003 S.A.



Pol. Ind. La Ferrería. c/ Progrès, 55 (Esquina Química). 08110 Montcada i Reixac. Barcelona

Tel: 935 751 510. Fax: 935 646 699

Horario:

De 8 a 13.30h y de 15 a 18.30h.

Viernes de 8 a 13.30h y de 15 a 17.30h.

	ZONA 1	ZONA 2	ZONA 3	ZONA 4
Pedidos hasta 350€	65€	95€	190€	A consultar
Pedidos entre 350€ y 1.200€	55€	80€	155€	A consultar
Pedidos > 1.200€	40€	65€	130€	A consultar

PORTES IRONLUX GROUP - CONDICIONES GENERALES

- Material entregado en destino (longitud máxima 8 metros)
- Para longitudes superiores a 8 metros y zonas de difícil acceso para nuestro camión, consultar precio del vehículo adecuado.
- Los precios no incluyen descarga con camión grúa.

ZONA PORTES

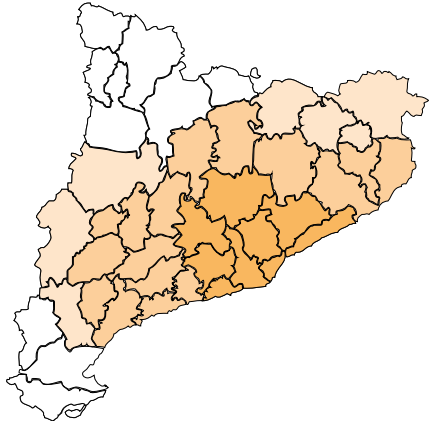

ZONA 1

- ALT PENEDES
- ANOIA
- BAGES
- BAIX LLOBREGAT
- BARCELONES
- GARRAF
- MARESME
- VALLES OCCIDENTAL
- VALLES ORIENTAL

ZONA 2

- ALT CAMP
- BAIX CAMP
- BAIX EMPORDA
- BAIX PENEDES
- BERGUEDA
- CONCA DE BARBERA
- GARRIGUES
- GIRONES

- LA SELVA
- OSONA
- PLA D' URGELL
- PRIORAT
- SOLSONES
- SEGARRA
- TARRAGONES
- URGELL

ZONA 3

- ALT EMPORDA
- GARROTXA
- NOGUERA
- PLA DE L'ESTANY
- RIBERA D'EBRE
- RIPOLLES
- SEGRIA

ZONA 4

- VIELHA
- PALLARS SOBIRA
- CERDANYA
- ALT URGELL
- ALTA RIBAGORÇA
- PALLARS JUSSA

- TERRA ALTA
- BAIX EBRE
- MONTSIA

DISTRIBUCIÓN POR ALMACENES

ALMACÉN BARCELONA

- ÁLAVA
- ASTURIAS
- ÁVILA
- BARCELONA
- BURGOS
- CANTABRIA
- GUIPÚZCOA
- GIRONA
- HUESCA
- LA CORUÑA
- LA RIOJA
- LEÓN
- LLEIDA
- LUGO
- NAVARRA
- OURENSE
- PALENCIA
- PONTEVEDRA
- PALMA DE MALLORCA
- SALAMANCA
- SEGOVIA
- SORIA
- TARRAGONA
- TERUEL
- VALLADOLID
- VIZCAYA
- ZAMORA
- ZARAGOZA
- FRANCIA
- PORTUGAL



ALMACÉN LEVANTE



CONDICIONES GENERALES DE VENTA

PEDIDOS

- El cliente deberá efectuar los pedidos en soporte escrito (fax, e-mail, etc), especificando al máximo cada una de las partidas del mismo. GM Group no se hace responsable de los errores derivados del incumplimiento de esta norma.
- Las fechas de entrega confirmadas por GM Group son de carácter aproximado/orientativo, sin que se admita responsabilidad ni cargos por el incumplimiento de las mismas.
- El material estándar se reservará en nuestras instalaciones un máximo de 48h. A partir de ese momento, se considerará la reserva de material no efectiva.

PRECIOS

- Sobre ellos se aplicarán las condiciones específicas de cada cliente referidas a la fecha de expedición de la mercancía. Si no se especifica lo contrario no incluyen portes.
- GM Group se reserva el derecho de modificar precios de tarifa en caso de subidas de las materias primas empleadas.

PORTES

- GM Group se reserva el derecho de contratar transporte ajeno a la empresa, previo acuerdo con el cliente, facturando el mismo importe que éste deba abonar por el servicio.
- En el caso en que el cliente solicite un cambio de ruta una vez iniciada ésta, los costes derivados de dicha acción irán enteramente a cargo del cliente.

EMBALAJES

- Estos serán los normales según las mercancías recibidas por nuestros proveedores. Otros embalajes que se soliciten, irán a cargo del cliente.

IMPUESTOS

- No incluidos en la tarifa. Serán aplicados de acuerdo con la legislación vigente.

CONDICIONES DE PAGO

- Salvo concesión de crédito en las condiciones que al efecto ambas partes convengan, el pago será al contado.
- El comprador comunicará la no conformidad con la factura en un plazo máximo de 15 días posteriores a la fecha de emisión de la misma. Toda reclamación posterior carecerá de validez.

ANULACIÓN Y DEVOLUCIONES

- No se tomará en cuenta ninguna anulación o cambio en la especificación de un pedido aceptado si éste ha sido fabricado.
- No se admitirá la devolución de ningún material suministrado, salvo que éste no sea conforme con las características indicadas en el pedido del cliente.
- El plazo máximo para presentar una reclamación será de 24 horas.

FACTURACIÓN

- Los precios y condiciones de venta que se aplicarán serán los que rijan en el día de la expedición de la mercancía.

JURISDICCIÓN TRIBUNALES

- Se someten expresamente, vendedor y comprador, a la jurisdicción y competencia de los Juzgados y Tribunales de Barcelona, con renuncia de cualquier otro fuero o domicilio propio.

ENTRADA EN VIGOR

- Esta tarifa y condiciones de venta generales empezarán a regir a partir del 1 de junio de 2016, y anulan y sustituyen a las anteriores.

ANEXO

- La información aparecida en esta tarifa de precios es de carácter puramente orientativo, basada en la experiencia y proporcionada en buena fe y conforme a nuestros conocimientos, sin que ésta suponga ningún tipo de responsabilidad sobre sus diferentes aplicaciones dado que no se tiene ningún tipo de control sobre su uso final.
- GM Group se reserva el derecho de modificar cualquier tipo de dato reflejado en esta tarifa en cualquier momento y sin previo aviso.

DESCUENTOS

	FECHA					
CERRAMIENTOS	DESCUENTO					OBSERVACIONES
Panel Cubierta Estándar						
Panel Cubierta TEJA						
Panel Fachada Estándar						
Otros Paneles						
Panel a medida						
Panel Lana de Roca						
Panel Frigorífico						
Chapa Metálica						
Chapa Metálica para Tabiques Pluviales						
LUCERNARIOS	DESCUENTO					
Policarbonato Celular Estándar						
Policarbonato Celular Bajo Pedido						
Sistemas de policarbonato						
Policarbonato Corrugado						
Poliéster						
Policarbonato Compacto y Metacrilato						
Lucernario Tubular						
Claraboyas de Metacrilato						
Sistemas de ventilación y Exutorios						
Ventanas ROTO	DESCUENTO					
ACCESORIOS	DESCUENTO					
Rematería Estándar						
Rematería Panel Teja						
Rematería a medida						
Accesorios de Policarbonato						
Sistemas de evacuación de aguas						
Accesorios Frigoríficos						
Fijaciones						
Pegado y Sellado						
Estructura						
COMERCIAL:	TELÉFONO:				EMAIL:	

ALMACEN BARCELONA

Pol. Ind. La Ferrería
c/ Progrès, 55 (Esquina Química)
08110 Montcada i Reixac
Barcelona
Tel: 935 751 510
Fax: 935 646 699

Horario:
De 8 a 13.30h y de 15 a 18.30h.
Viernes de 8 a 13.30h y de 15 a 17.30h.
info@ironlux.com

ALMACEN LEVANTE

C/ Vial de los Cipreses, 4
03006 Alicante
Alicante
Tel: 965 401 548
Fax: 966 682 215

Horario:
De 8 a 13.30h y de 15.30 a 19h.
Viernes de 8 a 13.30h y de 15.30 a 18h.
info@ironlux.es

